

WINGO INC[®]
A Division of DTE Dyna Technology Inc

**PACKAGE
STANDBY
SYSTEMS**

**PSS50LS/F
PSS75LS/D**

**INSTALLATION AND
OPERATIONS MANUAL**

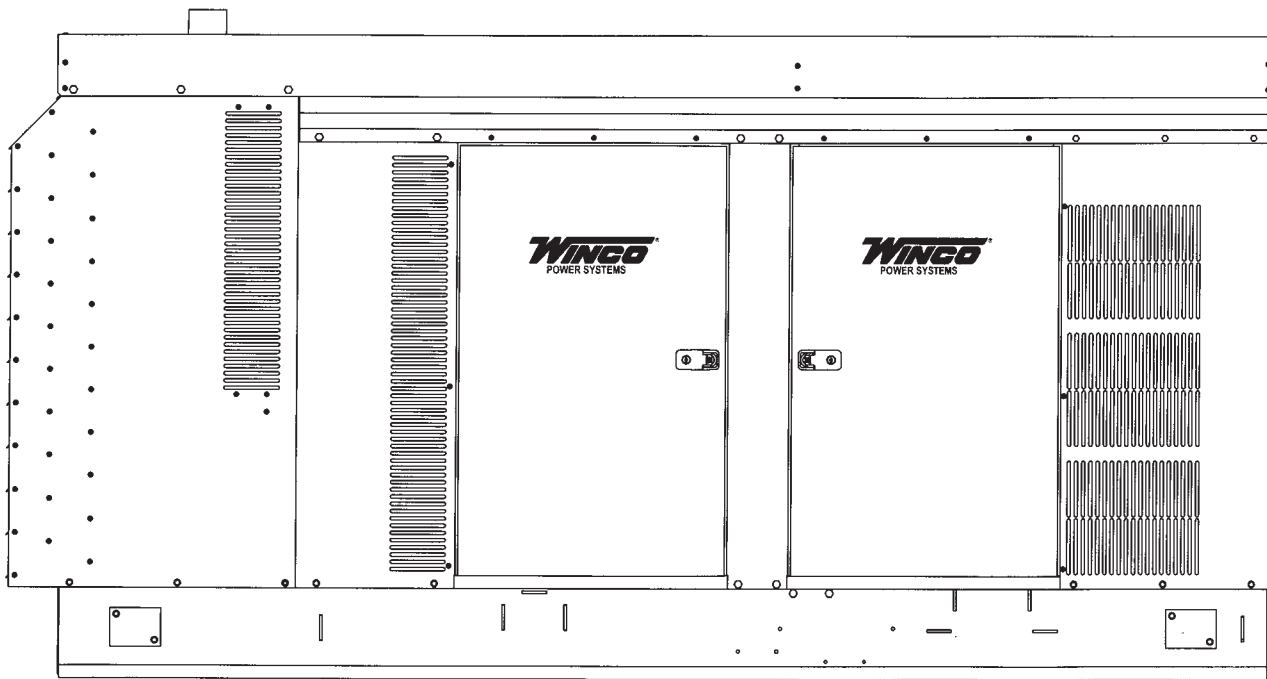

Engine Generator Set

SAVE THESE INSTRUCTIONS

This manual contains important instructions that should be followed during installation and maintenance of the generator and batteries.

Read and understand all instructions in the manual before starting and operating the generator set.

USING THIS MANUAL

Congratulations on your choice of a Winco generator set. You have selected a high-quality, precision-engineered generator set designed and tested to give you years of satisfactory standby service.

To get the best performance from your new engine generator set, it is important that you carefully read and follow the operating instructions in this manual.

Should you experience a problem please follow the "Things To Check" near the end of this manual. The warranty listed in this manual describes what you can expect from WINCO should you need service assistance in the future.

COPY YOUR MODEL AND SERIAL NUMBER HERE

No other WINCO generator has the same serial number as yours. It is important that you record the number and other vital information here. If you should ever need to contact us on this unit it will help us to respond to your needs faster.

MODEL _____

SERIAL NUMBER _____

PURCHASE DATE _____

DEALER _____

TABLE OF CONTENTS

INTRODUCTION	i
GUIDE TO PRODUCT SAFETY	1
BASIC INFORMATION	2
Description	2
DGC-2020 Engine Control Layout	3
Specification Table	4
PREPARING THE UNIT	5
Unpacking the unit	5
ENGINE GENERATOR INSTALLATION	5
Installation	6
Fuel Line Installation	6
Fuel Pressure Tables	6
LP Liquid Withdrawal	7
Lubrication	7
Coolant	7
Battery Installation	7
Battery Charger/Block Heater Wiring	8
AC Electrical Connections	8
DC Electrical Connections	9
INITIAL START-UP	11
EXERCISER CLOCK	11
TROUBLESHOOTING INFORMATION	12
LP/NG CONVERSION	11
OUTLINE DRAWING	13
AC WIRING - THREE PHASE	
277/480 Volt	14
120/208 Volt	14
120/240 Volt	15
AC WIRING - SINGLE PHASE	
120/240 Volt	15
VOLTAGE REGULATOR WIRING	16
DC SCHEMATIC - WIRING DIAGRAM	17
12 MONTH WARRANTY	18

PROPER USE AND INSTALLATION

You must be sure your new engine generator set is:

- * Properly serviced before starting
- * Operated in a well ventilated area
- * Properly exhausted and gases safely dispersed
- * Wired by a qualified electrician
- * Operated only for its designed purposes
- * Used only by operators who understand its operation
- * Properly maintained

IMPORTANT SAFETY INSTRUCTIONS

SAVE THESE INSTRUCTION

This manual contains important instructions that should be followed during installation and maintenance of the generator and batteries.

Read and understand all instructions in the manual before starting and operating the generator set.

This engine generator set has been designed and manufactured to allow safe, reliable performance. Poor maintenance, improper or careless use can result in potential deadly hazards; from electrical shock, exhaust gas asphyxiation, or fire. Please read all safety instructions carefully before installation or use. Keep these instructions handy for future reference. Take special note and follow all warnings on the unit labels and in the manuals.

ANSI SAFETY DEFINITIONS

DANGER:

DANGER indicates an imminently hazardous situation which, if not avoided, will result in death or serious injury. This signal word is to be limited to the most extreme situations.

WARNING:

WARNING indicates a potentially hazardous situation which, if not avoided, could result in death or serious injury.

CAUTION:

CAUTION indicates a potentially hazardous situation which, if not avoided, may result in minor or moderate injury. It may also be used to alert against unsafe practices.

NOTE:

CAUTION is also used on the unit labels and in this manual to indicate a situation that could result in serious damage or destruction of the equipment and possible personal injury.

1. **ELECTRIC SHOCK** - The output voltage present in this equipment can cause a fatal electric shock. This equipment must be operated by a responsible person.
 - a. Do not allow anyone to operate the generator without proper instruction.
 - b. Guard against electric shock.
 - c. Avoid contact with live terminals or receptacles.
 - d. Use extreme care if operating this unit in rain or snow.
 - e. Use only three-prong grounded receptacles and extension cords.
 - f. Be sure the unit is properly grounded to an external ground rod driven into the earth.

2. **FIRE HAZARD** - Natural gas and L.P. present a hazard of possible explosion and/or fire.
 - a. Do not smoke or use open flame near the generator set.
 - b. Keep a fire extinguisher nearby and know its proper use. Fire extinguishers rated ABC by NFPA are appropriate.
3. **DEADLY EXHAUST GAS** - Exhaust fumes from any gasoline engine contain carbon monoxide, an invisible, odorless and deadly gas that must be mixed with fresh air.
 - a. Operate only in well ventilated areas.
 - b. Never operate indoors.
 - c. Never operate the unit in such a way as to allow exhaust gases to seep back into closed rooms (i.e. through windows, walls or floors).
4. **NOISE HAZARD** - Excessive noise is not only tiring, but continual exposure can lead to loss of hearing.
 - a. Use hearing protection equipment when working around this equipment for long periods of time.
 - b. Keep your neighbors in mind when permanently installing this equipment.
5. **CLEANLINESS** - Keep the generator and surrounding area clean.
 - a. Remove all grease, ice, snow or materials that create slippery conditions around the unit.
 - b. Remove any rags or other material that could create potential fire hazards.
 - c. Carefully wipe up any gas or oil spills before starting the unit.
 - d. Never allow leaves or other flammable material to build up around the engine exhaust area.
6. **SERVICING EQUIPMENT** - All service, including the installation or replacement of service parts, **should be performed only by a qualified technician.**
 - a. Use only factory approved repair parts.
 - b. Do not work on this equipment when fatigued.
 - c. Never remove the protective guards, cover, or receptacle panels while the engine is running.
 - d. Use extreme caution when working on electrical components. High output voltages from this equipment can cause serious injury or death.
 - e. Always avoid hot mufflers, exhaust manifolds, and engine parts. They all can cause severe burns instantly.
 - f. Installing a generator set is not a "do-it-yourself" project. Consult a qualified, licensed electrician or contractor. The installation must comply with all national, state, and local codes.
 - g. Always make sure unit is disabled before placing your hands anywhere near the fan, belts, alternator or water hoses.

TESTING POLICY:

Before any generator is shipped from the factory, it is fully checked for performance. The generator is loaded to its full capacity, and the voltage, current, and frequency are carefully checked.

Rated output of generators is based on engineering tests of typical units, and is subject to, and limited by, the temperature, altitude, fuel, and other conditions specified by the manufacturer of the applicable engines.

INTRODUCTION AND DESCRIPTION

The package standby engine generator set includes all items necessary for a completely automatic standby power system as standard equipment. The entire package is then tested to insure proper operation of all components and the total system performance and reliability.

DESCRIPTION

This package power system is designed to automatically provide standby power to unattended loads during electrical outages. Upon an interruption of normal electrical service this package power system's electrical control circuits will automatically start the engine. The generator will produce electrical power and the Automatic Transfer Switch (A.T.S.) will automatically transfer the electrical loads to the engine-generator set. Upon restoration of normal electrical service the A.T.S. will sense return of the normal commercial power and retransfer the load back to normal commercial power source. The engine control circuits shut off the run signal to the engine generator set.

These package power systems consist of two major components:

1) AUTOMATIC TRANSFER SWITCH (UL LISTED)

The Automatic Transfer Switches (A.T.S.) is a wall mount switch designed for inside installation. A electronic exerciser circuit is installed in the A.T.S. as standard equipment. The A.T.S. also contains the power failure sensing circuitry necessary to send a start/stop signal to the engine generator set. The following is a list of recommended A.T.S. sizes for each model. Outside switches as well as additional sizes are available, consult your sales rep for additional information.

MODEL	VOLTAGE	RECOMMENDED ATS AMPERAGE
PSS50LS-3	120/240	400
PSS50LS-4	120/208	200
PSS50LS-17	120/240	200
PSS50LS-18	277/480	100
PSS75LS-3	120/240	400
PSS75LS-4	120/208	400
PSS75LS-17	120/240	400
PSS75LS-18	277/480	200

Additional optional A.T.S. sizes are available to meet specific needs. Contact your local WINCO dealer or the WINCO Sales Department for a quote.

2) ENGINE/GENERATOR

PSS50LS- The engine generator set consists of a GM 5.7L, V-8 industrial, liquid cooled engine equipped to run on L.P./N.G. fuel. The engine operates at 1800 rpm and frequency regulation is maintained by the electronic governor within .5 cycles variation, from no load to rated load. The 50,000 watt (50kW) generator is a single bearing, direct drive, rotating field design. The generator is connected to the engine flywheel via flexible drive disks. The engine generator is mounted in a weather proof enclosure for outside installation. Connection boxes are provided to all customer connections (both AC output and DC control). A **customer supplied** 12 Volt, 650 CCA (BCI group 24) battery is required to complete the installation. Engine operation is controlled by a Digital Genset Controller (DGC) mounted in the engine generator enclosure.

PSS75LS - The engine generator set consists of a GM 5.7L, Turbo charged V-8 industrial, liquid cooled engine equipped to run on L.P./N.G. fuel. The engine operates at 1800 rpm and frequency regulation is maintained by the engine governor within .5 cycles variation, no load to rated load. The 75,000 watt (75kW) generator is a single bearing, direct drive, rotating field design. The generator is connected to the engine flywheel via flexible drive disks. The engine generator is mounted in a weather proof enclosure for outside installation. Connection boxes are provided to all customer connections (both AC output and DC control). A **customer supplied** 12 Volt, 650 CCA (BCI group 24) battery is required to complete the installation. Engine operation is controlled by a Digital Genset Controller (DGC) mounted in the engine generator enclosure.

** NOTICE **

These units will automatically transfer if a power outage occurs while running in an exercise mode.

ENGINE CONTROL MODULE (DGC-2020)

The DGC-2020 Digital Genset Controller provides integrated engine-genset control, protection, and metering in a single package. Microprocessor based technology allows for exact measurement, set point adjustment, and timing functions. Front panel controls and indicators enable quick and simple DGC-2020 operation. Basler Electric communication software (BESTCOMSPPlus) allows units to be easily customized for each application. A wide temperature-range liquid crystal display (LCD) with backlighting can be viewed under a wide range of ambient light and temperature conditions.

FEATURES

DGC-2020 Digital Genset Controllers have the following features:

- Local and Remote Generator Control
- Engine and Generator Protection
- Programmable Analog Engine Senders
- Programmable Logic
- Automatic Transfer Switch Control (Mains Failure)
- Integrated RS485
- Auto Synchronizing

FUNCTIONS

DGC-2020 Digital Genset Controllers perform the following functions:

Generator Protection and Metering

Generator protection guards against over voltage, under voltage, under frequency, and over frequency. Over current and phase imbalance protection is available as an option at the time of manufacture. Each generator protection function has an adjustable pickup and time delay setting. Metered generator parameters include voltage, current, real power (watts), apparent power (VA), and power factor (PF).

Engine Protection and Metering

Engine protection features include oil pressure and coolant temperature monitoring, over crank protection, ECU specific protection elements, and diagnostic reporting. Metered engine parameters include, oil pressure, coolant temperature, battery voltage, speed, engine load, coolant level (from ECU), ECU specific parameters, and run-time statistics.

All metering functions are displayed on the liquid crystal display. The front panel display begins with the SUMMARY SCREEN. Pressing the *Right* arrow key will open the MAIN MENU screen. The MAIN MENU screen consists of METERING and SETTINGS

Summary Screen

Summary screen can be set to standard or scrolling. When set to standard, only the following are displayed:

- Generator Voltage
- Generator Amperage
- Generator Phase
- Generator Frequency
- Engine Oil Pressure
- Engine Coolant Temperature
- Engine Battery Voltage

ENGINE CONTROL MODULE DGC-2020

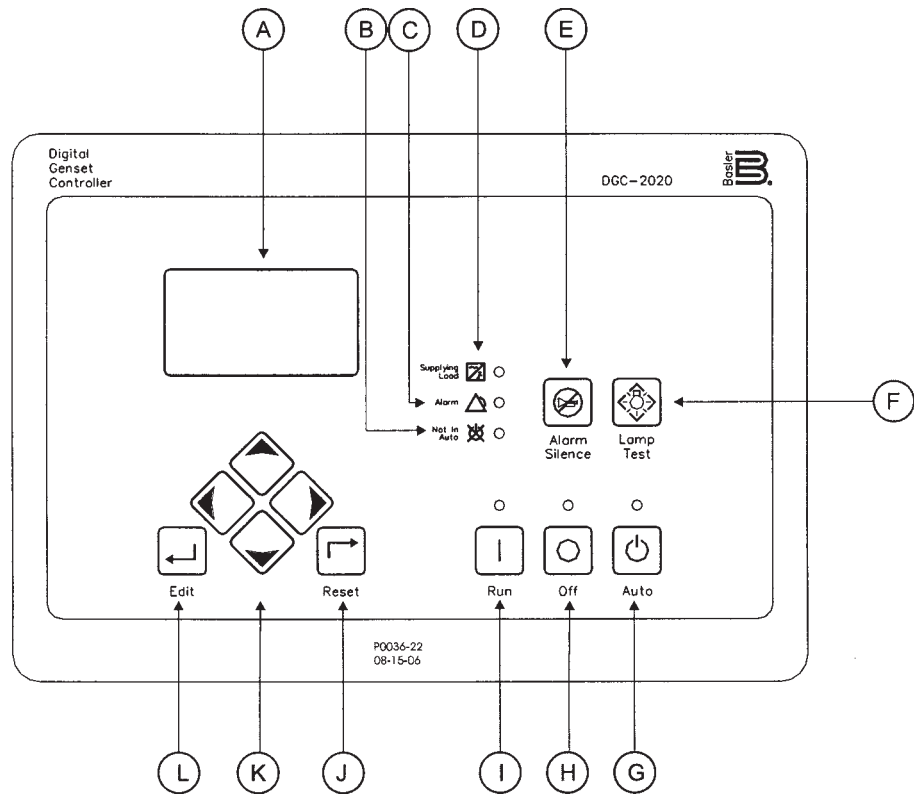

A - Liquid Crystal Display. The backlit, 64 by 128 pixel LCD serves as the local information source for metering, alarms, pre-alarms, and protective functions. Display operation is maintained at -20°C. An optional LCD heater maintains display operation at -40°C.

B - Not in Auto Indicator. This red LED lights when the DGC-2020 is not operating in Auto mode.

C - Alarm Indicator. This red LED lights continuously during alarm conditions and flashes during pre-alarm conditions.

D - Supplying Load Indicator. This green LED lights when the generator current is greater than EPS threshold current.

E - Alarm Silence Push-button. Pressing this button opens the relay output programmed as the horn output.

F - Lamp Test Push-button. Pressing this button tests the DGC-2020 indicators by exercising all LCD pixels and lighting all LEDs.

G - Auto Push-button and Mode Indicator. Pressing the Auto button places the DGC-2020 in Auto mode. The green Auto mode LED lights when Auto mode is active.

H - Off Push-button and Mode Indicator. Pressing this button places the DGC-2020 in Off mode. The red Off mode LED lights when the DGC-2020 is in Off mode.

I - Run Push-button and Mode Indicator. Pressing this button places the DGC-2020 in Run mode. The green Run mode LED lights when Run mode is active.

J - Reset Push-button. This button is pressed to cancel a settings editing session and discard any settings changes. When pressed, this button also resets the Breaker Management Pre-Alarms

K - Arrow Push-buttons. These four buttons are used to navigate through the front panel display menus and modify settings. The left- and right-arrow buttons are used to navigate through the menu levels. The right arrow button is pressed to move downward through the menu levels and the left-arrow button is pressed to move upward. Within a level, the up-arrow and down-arrow buttons are used to move among items within the menu level. Pressing the down-arrow button moves to items lower in the list. Pressing the up-arrow button moves to items higher in the list. During a settings editing session, the up- and down-arrow buttons are used to raise and lower the value of the selected setting.

L - Edit Push-button. Pressing this button starts an editing session and enables changes to the DGC-2020 settings. At the conclusion of an editing session, the Edit push-button is pressed again to save the setting changes.

DISPLAY OPERATION

The front panel display is used to make settings changes and display metering values. Refer to call-outs J, K, and L in text and illustration for information on changing settings through the front panel and navigating through the Metering screens. When the unit is first powered up, the clock may need to be reset. Editing the clock provides familiarity with the edit process. All programming changes from the front panel are accessed through the edit key to begin and exit the internal microprocessor program.

Log-in and Permissions

To Log-in, navigate to the SETTINGS, ENTER PASSWORD screen and press the Edit key. Use the Up/Down arrow keys to scroll through the characters. Use the Left/Right arrow keys to enter more characters. The Owner operator password is OP. Once the password has been entered, press the Edit key to Log-in. See the key stroke sequence listed below to access the control and enter the edit mode. A LOGOUT selection now appears in the list of SETTINGS. To logout, navigate to SETTINGS, LOGOUT and press the Edit key. The LOGOUT selection is removed from the SETTINGS list.

Sequence for setting (or resetting) the system clock -

- 1) Press 'K' (right key) for initial set or 'K' (left to back up, up / down) to choose menu item and time/date element to be changed.
- 2) Press 'L' (Edit) to access change mode to enter Password - OP as follows:
 - 2a -Press K (up) to select O
 - 2b -Press K (right) to move cursor
 - 2c -Press K (up) to select P
 - 2d -Press L (Edit) to begin change mode
- 3) Press 'K' (up or down) to choose year
- 4) Press 'L' (Edit) to enter year
- 5) Press 'K' (down) to select month mode
- 6) Press 'L' (Edit) to access month change
- 7) Press 'K' (up or down) to choose month
- 8) Press 'L' (Edit) to enter month

- 9) Repeat sequence 5 through 8 for day, minute, second and DST (Daylight Saving Time).
To finish clock setting, process - Press 'K' (left).

The microprocessor is still in the General Settings Edit mode. Pressing 'K' (left) a second time exits the Edit mode and allows full access to the View Only mode for all control settings and current status. Any items to be changed are accessed by pressing 'K' (up/down/right or left) to select, 'L' (Edit) to change and 'K' (left) to exit.

SPECIFICATIONS

GENERATOR

MODEL	WATTS	VOLTS	AMP	HZ	PH	RPM
PSS50LS-3	50,000	120/240	208*	60	1	1800
PSS50LS-4	50,000	120/208	174*	60	3	1800
PSS50LS-17	50,000	120/240	151*	60	3	1800
PSS50LS-18	50,000	277/480	75*	60	3	1800
PSS75LS-3	75,000	120/240	312**	60	1	1800
PSS75LS-4	75,000	120/208	261**	60	3	1800
PSS75LS-17	75,000	120/240	225**	60	3	1800
PSS75LS-18	75,000	277/480	113**	60	3	1800

*Derate 11% for Natural Gas operation. Derate 3.5% per 1000 feet elevation above sea level.

**Derate 7% for LP operation. Derate 3.5% per 1000 feet elevation above sea level.

FUEL CONSUMPTION

MODEL	NG (1,000 BTU/CU FT)		L.P. VAPOR (2,520 BTU/CU FT)			
	CF/HR	BTU/HR	#/HR	GAL/HR	CF/HR	BTU/HR
PSS50LS	725	725,000	36.0	8.5	300	756,000
PSS75LS	1000	1,000,000	43.2	10.2	360	907,200

L.P. TANK SIZING

Minimum required L.P. Tank size for L.P. Vapor withdrawal operating at various outside temperatures given in degrees Fahrenheit (Celsius)

TANK TEMPERATURE

MODEL	60 F(16 C)	30 F(0 C)	0 F(-18 C)	-20 F(-29 C)
PSS50LS	500 Gal	1000 Gal	1500 Gal*	5000 Gal*
PSS75LS	500 Gal.	1000 Gal.	2000 Gal.*	5000 Gal.*

*Recommend liquid withdrawal at these temperatures.

ENGINE SPECIFICATIONS:

Refer to engine operating and maintenance instructions

** NOTICE **

Regarding Engines - This manual covers the generator portion of these units. See the separate engine instruction manual for engine-related problems, detailed engine information and engine warranty.

** CAUTION **

EQUIPMENT DAMAGE - Be sure to check the engine oil level frequently as specified in the engine manual.

The engine manufacturer has established an excellent world-wide engine service organization; engine service is available from a nearby authorized dealer or distributor; check the Yellow Pages of the telephone directory under "engines," or ask the dealer from whom you purchased the power plant.

The rated power of each engine-generator is limited by the temperature, altitude and all other ambient conditions specified by the engine manufacturer. Engine power will decrease 3-1/2% for each 1000 ft. above sea level, and will decrease an additional 1% for each 10 degrees Fahrenheit above 60 degrees Fahrenheit. Units should not be operated in ambient temperature greater than 40°C.

UNPACKING INSTRUCTIONS

** NOTICE **

When unpacking the generator set, be sure to inspect it carefully for freight loss or damage. If loss or damage is noted at the time of delivery, require that the person making the delivery make note of the loss or damage on the freight bill, or affix his signature under the consignee's memo of the loss or damage. Contact the carrier for claim procedures.

When loss or damage is noted after delivery, segregate the damaged material, and contact the carrier for claim procedures.

"Concealed Damage" is understood to mean damage to the contents of a package which is not in evidence at the time of delivery by the carrier, but which is discovered later. The carrier or carriers are responsible for merchandise lost or damaged in transit. The title to goods rests with the consignee when generators are shipped FOB factory, and only the consignee can legally file a claim.

**** CAUTION ****

EQUIPMENT DAMAGE - *These units are shipped with oil, and a 50/50 mix of coolant. Be sure to check all fluid levels before operating. See engine manufacturer's instruction manual for recommended oil requirements before initial starting.*

UNPACKING:

1. Carefully remove the carton.
2. After inspecting the engine-generator for external physical damage, check for the following items packed inside the carton:
 - a. Owner's manual and wiring diagram.
 - b. Engine manufacturer's instruction manual.
3. Remove main frame hold down bolts, (6).
4. Unit can now be lifted from shipping rails.

INSTALLATION

**** **WARNING** ****

PERSONAL INJURY - *Before proceeding with the installation, be sure the operation selector switch is in the "stop" position.*

General Information

These engine generator sets are for outdoor installation. These units must be bolted solidly to a concrete pad. The transfer switch is mounted next to your distribution panel inside the building. Consult a qualified, licensed electrician or contractor to install and wire the transfer switch. The installation must always comply with all national, state, and local codes.

**** CAUTION ****

EQUIPMENT DAMAGE - *These units must be mounted on a solid concrete pad to prevent air from exiting under the unit. Allowing air to exit under the unit may cause the unit to overheat from lack of proper air flow.*

Before beginning the installation process recheck the rating of the generator set and its transfer switch rating. Be certain they can handle the intended load and are compatible with the entrance voltage, phase and current ratings. Plans for installation should be prepared with proper attention to mechanical and electrical engineering detail to assure a satisfactory system installation. The information in this manual is offered only as a guide to finalizing your installation plans. For full service switching the A.T.S. must have a fusible disconnect (circuit breaker) installed before the switch to protect the contacts.

ENGINE GENERATOR SET MOUNTING

The unit's main frame should be bolted solidly to a 4 to 6 inch thick cement pad. The engine-generator is mounted on a sub-frame which is attached with special shock mounts to the main frame. This allows the engine-generator free movement without affecting the control panel which is mounted on the main frame.

Do not shock mount the main frame. Engine vibration will be transmitted to the control panel causing erroneous start/stop cycles and premature control failure.

The unit should be mounted to allow for ample working room around it. A general rule to follow is five (5) feet clearance on all sides. See NFPA Code 37 for additional clearance requirements.

FUEL INSTALLATION

The fuel supply should be as close as possible to the engine. This will reduce the installation cost of fuel runs. The information in this manual is offered to assist you in providing the proper fuel for your engine. However, this information is only provided to inform you of the engine's requirements and assist in making you aware of the decisions you must make. In no case should the instructions or information provided be interpreted to conflict with any local, state or national codes. If in doubt, always consult your local fire marshal or gas supplier.

**** **WARNING** ****

FIRE HAZARD - *All fuel runs should be installed by a licensed fuel supplier.*

Connect the fuel supply to the inlet of the fuel solenoid (see table for recommended line size). The pressure at the secondary demand regulator must be four to six ounces psi (per square inch) or 7 to 11 inches W.C. (Water column) for vapor withdrawal units. On units equipped with liquid withdrawal fuel systems full tank pressure is plumbed to the fuellock strainer mounted on the generator rails. The fuel converter mounted on the unit will handle both vaporization of the fuel and pressure reduction.

INSTALLING THE FUEL LINE

** NOTICE **

The engine generator sets are properly adjusted before they leave the factory for a specific fuel, either NG (natural gas), LP (liquid propane vapor) or LPG (liquid withdrawal propane). This fuel type is noted in your model number. If it becomes necessary to change the fuel type in the field see information on page 12.

Line Size (vapor system)

Unit location will determine the size of fuel line that is required to supply the engine with a constant fuel pressure. Refer to the tables below for fuel line size, fuel consumption and recommended tank size. For distances of 25 feet and over, a two regulator fuel system is recommended. This is accomplished by installing a primary regulator at the tank which will reduce the tank pressure down to 10 to 15 lbs. A secondary regulator is installed to further reduce the fuel pressure to the required six (6) oz operating pressure. This secondary regulator must be at least 10 feet from the engine generator set. Any closer installation will require a larger line be installed to provide a fuel reservoir. If this is not done, the demand regulator on the unit and the pressure regulator in the fuel line will interfere with each other. When this two (2) stage regulator system is used, a fuel line size of 3/4 to 1 inch is generally adequate for distances up to 300 feet from the primary to the secondary regulator. (Consult your local fuel supplier for your exact requirements). The appropriate line size from the table below is then installed from the secondary regulator to the generator set.

****** WARNING ******

PERSONAL DANGER - Do not use galvanized pipe in fuel line runs. The galvanized coating can become eroded and flake off, causing possible obstructions in the regulator or fuel valve. The results could range from inoperative engine start to hazardous fuel leaks.

Size of pipe normally required for generators operating on NATURAL/LP gas:

	up to 25 feet*	over 25 feet*
PSS50LS	1" pipe	not recommended
PSS75LS	1" pipe	use a two regulator system

* Allow an additional 3 feet for each standard elbow.
 Do not use 'street ells' (restrictive).

**** CAUTION ****

EQUIPMENT DAMAGE - Be careful when sealing gas line joints. Excessive sealing compound can be drawn into the solenoid, regulator or carburetor causing an engine malfunction.

FUEL PRESSURE (vapor system)

Correct fuel pressure cannot be stressed enough. The most common cause for inoperative systems is an inadequate or incorrect fuel pressure. Performance of the engine is in direct relation to the correctness of the fuel system. Shown below is a block diagram of a typical L.P. or N.G. Installation.

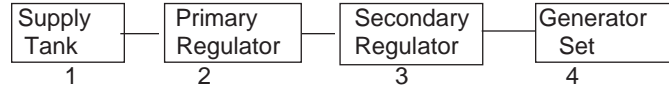

TWO (2) REGULATOR FUEL SYSTEM

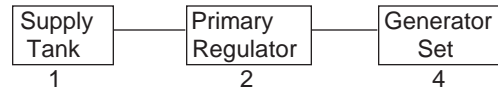

SINGLE REGULATOR FUEL SYSTEM

Reference numbers 1 through 3 in the block diagrams above are fuel lines supplied by customer.

Reference number 4 is the engine generator set.

Below is a table of the fuel pressure readings at each reference in the system.

Fuel Pressure Table

Single Regulator (L.P. Vapor only)

	1	2	3
UNIT OFF	TANK PSI	7-11 in 4-6 oz	7-11 in 4-6 oz
STARTING	TANK PSI	7-11 in 4-6 oz	7-11 in 4-6 oz
NO LOAD	TANK PSI	7-11 in 4-6 oz	7-11 in 4-6 oz
FULL LOAD	TANK PSI	7-11 in 4-6 oz	7-11 in 4-6 oz

Two (2) Regulator System (L.P. Vapor only)

	1	2	3	4
UNIT OFF	TANK PSI	10-15 lbs	7-11 in 4-6 oz	7-11 in 4-6oz
STARTING	TANK PSI	10-15 lbs	7-11 in 4-6 oz	7-11 in 4-6 oz
NO LOAD	TANK PSI	10-15 lbs	7-11 in 4-6 oz	7-11 in 4-6 oz
FULL LOAD	TANK PSI	10-15 lbs	7-11 in 4-6 oz	7-11 in 4-6 oz

Natural Gas

	1	2	4
UNIT OFF	LINE PSI	7-11 in 4-6 oz	7-11 in 4-6 oz
STARTING	LINE PSI	7-11 in 4-6 oz	7-11 in 4-6 oz
NO LOAD	LINE PSI	7-11 in 4-6 oz	7-11 in 4-6 oz
FULL LOAD	LINE PSI	7-11 in. 4-6 oz	7-11 in 4-6 oz

Notice the preceding tables give two (2) different units of measuring fuel pressure. The first is with a pressure gauge calibrated in ounces per square inch. The second and most accurate is the use of a simple water manometer. A manometer is calibrated in inches of water column.

LP LIQUID WITHDRAWAL SYSTEMS

When installing a unit equipped the LP liquid withdrawal a primary regulator is not required on the supply tank. The supply line is connected to a liquid withdrawal valve on the supply tank and runs directly to the fuellock strainer mounted on the engine generator set. Normally a 3/8 inch copper line is acceptable for this type of fuel installation. You must be sure that the valve you have connected to on the supply tank is in fact a liquid supply valve and has a drop tube inside the tank that is pulling fuel from the bottom of the supply tank. Before starting the unit you must confirm that you have a good liquid supply at the unit. **Engine generator sets equipped for liquid withdrawal will not run properly when supplied with high pressure vapor fuel.**

LUBRICATION

Before starting the engine, check the oil level in the crankcase. If it is low, refill to the full mark with the proper weight/grade of oil as recommended by the engine manufacturer's maintenance instructions. The necessity of using the correct oil, and keeping the crankcase full cannot be over emphasized. Failure to use the proper oil and keep the crankcase properly filled will cause excessive engine wear and shorten its useful life.

COOLANT

Before starting the engine, check the coolant level in radiator. If it is low, refill as specified in the engine manufacturer's maintenance instructions. The radiator should be filled to about 1 inch below the filler neck. For additional information on engine coolant requirements see engine manufacturer's maintenance instructions.

INSTALLING THE BATTERY

**** CAUTION ****

In the following battery installation procedure, check to be sure the selector switch remains in the "stop" position. This should be your last step before initial start-up.

A customer supplied twelve-volt battery is required to complete the installation. Installation of the highest CCA rated battery, within the correct BCI group, will increase cold weather starting performance. *Gel batteries should not be used* with the battery tender installed in the generator enclosure.

Model	Voltage	BCI Group	MINIMUM
			CCA Rating
PSS50LS	12	24	650
PSS75LS	12	24	650

Installation and servicing of batteries must be performed or supervised only by personnel knowledgeable of batteries and the required precautions. Keep unauthorized personnel away from batteries.

When installing or replacing batteries, use the proper group/size **starting** battery. The battery should be a Maintenance Free lead acid design. Deep cycle batteries will not work for this application.

CAUTION – PERSONAL DANGER

CAUTION - NEVER dispose of a battery in a fire. The battery is capable of exploding.

CAUTION - DO NOT open or mutilate the battery. Released electrolyte is known to be harmful to the skin and eyes and to be very toxic.

These engine generator sets are all **NEGATIVE** ground. Be very careful not to connect the battery in reverse polarity, as this may short circuit the battery charging system on the engine.

CAUTION – A battery presents a risk of electrical shock and high short circuit current. The following precautions must be observed when working with batteries.

1. Remove watches, rings and other metal objects.
2. Use tools with insulated handles.
3. Check both the battery cable ends and the battery posts to be sure they are free of corrosion.
3. Always connect the battery positive cable first and then connect the battery negative cable. When removing the battery cables from the battery reverse the procedure, disconnect the negative cable first and then the positive cable.
4. Be sure all connections are tight and coat the terminals and cable end with dielectric grease.

WARNING – The electrolyte is a diluted sulfuric acid that is harmful to the skin and eyes. It is electrically conductive and corrosive. The following precautions must always be taken.

- * Always wear full eye protection and protective clothing
- * Where electrolyte contacts the skin, wash off immediately with water.
- * If electrolyte contacts the eyes, flush thoroughly and immediately with water and seek immediate medical attention.
- * Spilled electrolyte is to be washed down with an acid neutralizing agent. A common practice is to use a solution of one pound of bicarbonate of soda (baking soda) to one gallon of water. The bicarbonate of soda solution is to be added until the evidence of reaction, foaming, has ceased. The resulting liquid is to be flushed with water and the area dried.

DANGER – Explosive Fire Risk

- * Never smoke when near batteries
- * Do not cause a flame or spark in the battery area
- * Always discharge static electricity from your body before touching batteries by first touching a grounded metal surface.

SERVICING BATTERIES

Batteries used on these units may over time lose water. This is especially true if you are using a trickle charger to maintain your battery. When refilling the battery with water use only distilled water. Tap water will shorten the service life of the battery.

Never fill the battery above the fill line. Over filling above the upper level line may cause the electrolyte to overflow, resulting in corrosion to the engine or nearby parts. Immediately wash off any spilled electrolyte following the procedure above.

NOTE: Always make sure that a new battery is fully charged before installing it on a generator set. Failure to do so can cause damage to the engine control module in the generator set.

All connections must be clean and tight. Check the electrolyte (fluid) in the battery periodically to be sure it is above the plates. Never allow the battery to remain in a discharged condition.

CONNECTING THE BATTERY CHARGER & BLOCKHEATER

A two-stage battery tender is provided on all standby generators. This battery tender charges at a rate of 750 mA until the battery is fully charged and then automatically switches to a 13.2 VDC float charger. The charger has an indicator light on it, red indicates it is charging, and green indicates it is in the storage mode (float charge). This charger is mounted on the engine generator set just below the engine control panel.

** NOTICE **

The trickle charger is not intended to recharge a battery which has become completely discharged. It is designed to produce just enough current to maintain a fully charged battery.

The battery tender receptacle is to be powered by a GFCI circuit and installed in accordance with the United States National Electric Code. These AC wires can be run in the same conduit as the other AC leads from the generator. It is suggested that this circuit be fused for 15 amps, then both the battery charger and the block heater can be connected to the same circuit. A 120 volt duplex receptacle is mounted on the generator along side circuit breaker panel, the battery tender is shipped already plugged into the receptacle.

The engine blockheater installed on this unit\ should also be plugged in this receptacle. The block heater is thermostatically controlled and when plugged in will maintain the engine coolant temperature between 100 and 120 degrees F.

MOUNTING THE AUTOMATIC TRANSFER SWITCH (A.T.S.)

******* WARNING *******

FIRE HAZARD - All wiring must be done by a licensed electrician, and must conform to the national electrical code and comply with all state and local codes and regulations. Check with the local authorities before proceeding!

INSTALLATION NOTES

Because of the many different types of service, feeder, and distribution equipment, no specific wiring instructions can be provided. It is recommended that only copper wire be used. In all cases it is essential that while the load is connected to the generator, there can be absolutely no feedback from the generator to the power line or the power line to the generator. When

properly installed, the normal A.T.S. Control and safety systems will eliminate all paths for feedback.

To wire the automatic transfer switch into the existing wiring, first determine which circuits will be on the emergency load circuit. If the entire load is to be transferred, the transfer switch can be wired in directly after the watt-hour meter and the service entrance, providing the service entrance ampere rating is within the transfer switch's rated capability.

If only specific circuits are to be powered under emergency power failure conditions, an additional distribution panel designated "emergency distribution panel" must be installed.

All selected emergency circuits are removed from main distribution panels and installed in the emergency distribution panel. The A.T.S. is then installed between the main panel and the emergency distribution panel. Suggested circuits: freezer, refrigerator, furnace, emergency lights, sump pump, emergency outlet circuits, etc. Total running load must not exceed generator rating.

A.C. ELECTRICAL CONNECTIONS

NOTICE - CLASS 1 WIRING METHODS ARE TO BE USED FOR ALL FIELD WIRING CONNECTIONS TO TERMINALS OF A CLASS 2 CIRCUIT

Note: This symbol  always indicates ground where used.

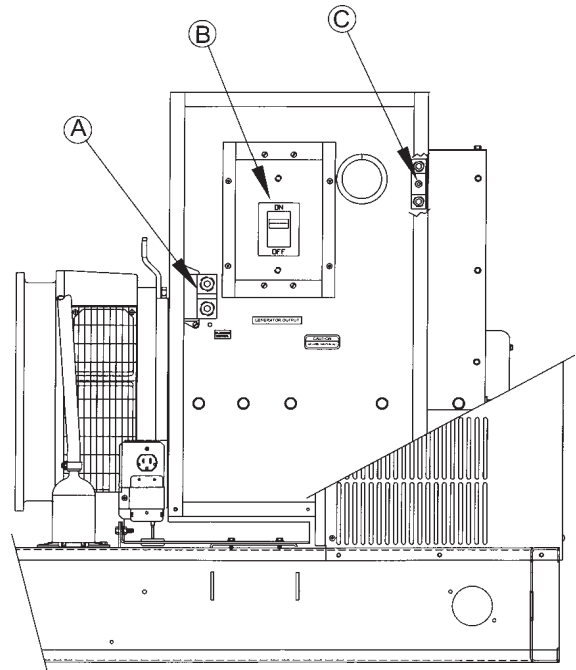

A - Neutral Lugs, These neutral lugs are isolated from ground and provided for you to connect your neutral wire from the transfer switch to. The lugs on the 75 kW will handle wire sizes #1 AWG to 400 MCM and should be torqued to 300 in. lbs. The lugs on the 50 kW will accommodate #4 AWG to 300 MCM and should be torqued to 250 in. lbs.

B - Generator Circuit Breaker, This circuit breaker provides overload protection for the generator. Your power feeds from the transfer switch will connect to the bottom lugs on the circuit breaker. The generator power feeds have already been wired into the upper lugs.

The table below gives you the circuit breaker size, lug wire sizes and torque specification. (see the actual breaker for additional information and restrictions)

kW	Voltage	PH	Amp	Wire Capability	Lug Torque
75	120/240	1	300	#1 AWG - 600 MCM	375 in lbs
75	120/208	3	250	#1 AWG - 600 MCM	375 in lbs
75	120/240	3	225	#4 AWG - 300 MCM	250 in lbs
75	277/480	3	100	#14 - #1/0 AWG	80 in lbs
50	120/240	1	200	#4 AWG - 300 MCM	250 in lbs
50	120/208	3	175	#4 AWG - 300 MCM	250 in lbs
50	120/240	3	150	#4 AWG - 300 MCM	250 in lbs
50	277/480	3	80	#14 - #1/0 AWG	80 in lbs

Minimum Conductor Sizes between the Generator and the ATS. Based on wire type and temperature rating. Wire has been derated for 40° C ambient temperatures.

kW	Voltage	PH	Amp	CU Conductor		AL Conductor	
				C/B	Wire Temperature Rating	75°C	90°C
75	120/240	1	300	500 MCM	350 MCM	600 MCM	500 MCM
75	120/208	3	250	300 MCM	250 MCM	400 MCM	350 MCM
75	120/240	3	225	300 MCM	4/0 AWG	350 MCM	300 MCM
75	277/480	3	100	#2 AWG	#2 AWG	1/0 AWG	#1 AWG
50	120/240	1	200	3/0 AWG	3/0 AWG	300 MCM	250 MCM
50	120/208	3	175	3/0 AWG	2/0 AWG	250 MCM	4/0 AWG
50	120/240	3	150	2/0 AWG	1/0 AWG	4/0 AWG	3/0 AWG
50	277/480	3	80	#3 AWG	#4 AWG	#1 AWG	#2 AWG

For additional information on wire sizing refer to table 310-16 of the National Electrical Code ANSI/NFPA 70.

C - Ground Lug, These ground lugs are bonded to ground and are provided for you to connect your ground wire from the transfer switch to. The lugs on the 75 kW will handle wire sizes #4 AWG to 300 MCM and should be torqued to 250 in. lbs. The lugs on the 50 kW will accommodate #1 AWG to 250 MCM and should be torqued to 250 in. lbs.

WARNING

A main line circuit breaker has been provided inside the generator housing. During all wiring installations make sure the breaker is in the off position and the generator operation switch is in the off position.

WARNING

EQUIPMENT DAMAGE - When installing a Three Phase 240 volt system be sure you know which lead is the high voltage "wild" leg (208Volt line to neutral). The generator normally carries the high voltage on the G2 lead.

The load current carrying wires (L) and (T) must be sized to handle the maximum load current without excessive voltage drop.

By code, the wire must be heavy enough to handle the full current rating of the main line circuit-breaker (or fuse) in the entrance (or sub-panel) protecting the contactor switch.

All wires should be installed in rigid or flexible conduit. (Knock-outs are provided in the control box).

See the manual shipped with the Automatic Transfer Switch for connection locations in the switch. Connections in each switch will vary depending on the type of switch and the manufacturer.

GROUNDING

A grounding lug has been provided on the engine generator set and the generator set must be properly grounded to good earth ground. Generally a 6 foot copper rod driven into the earth will provide a proper earth ground.

D.C. ELECTRICAL CONNECTIONS

All DC connections are completed in the small box just below the engine control cabinet. In addition there are two small fuses mounted on the top of the engine control cabinet that protect both the engine control and all the other DC connections. See the display below for additional information.

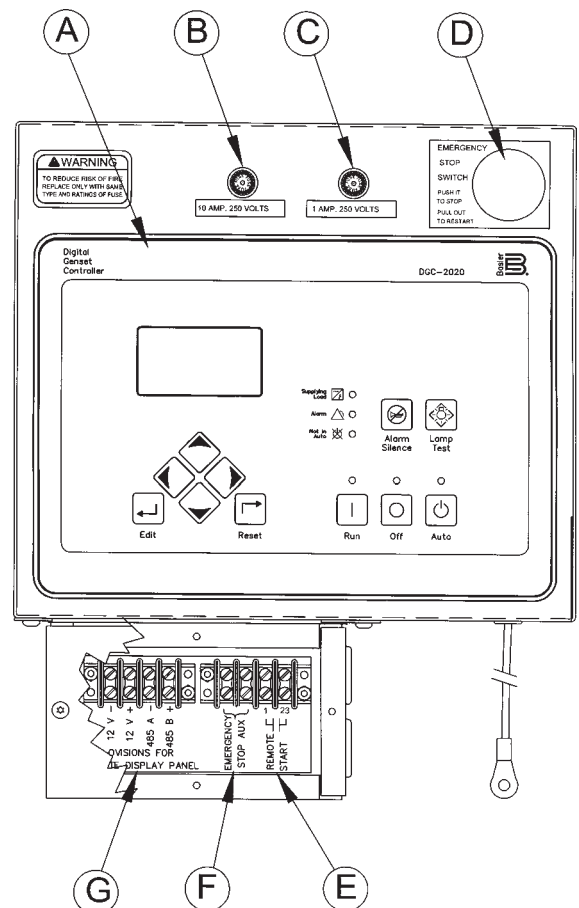

CONTROL PANEL LAYOUT

A - DGC-2020 Digital Gen-Set Control. See Explanation on page 3.

B - DC Control Circuit Fuse. The 10 amp DC Circuit Fuse protects the 12 volt circuits and engine wiring harness against faults in wiring or control equipment. The fuse also prevents a discharge of the battery due to a circuit fault. (Replacement AGC-10A-250V)

C - DGC-2020 Fuse. This 1 amp DC fuse protects the DGC-2020 printed circuit board. (Replacement AGC-1A-250V)

D - Emergency Stop Switch (3)- When depressed this switch will disconnect all the 12 volt power to the DGC-2020 shutting the engine down. The lamp in the emergency stop switch will light up when the switch is depressed showing that the power to the panel has been disconnected.

E - CUSTOMER REMOTE START CONNECTION TERMINALS -

The two remote start leads from the Automatic Transfer Switch are connected to the two terminals marked 1 & 23. The wire in terminal labeled #1 is Battery Negative and the wire in the terminal labeled #23 is your Remote Start lead. Closing these two leads together will signal the DGC-2020 to go into an auto-start mode and start up the engine generator.

Depending on the distance, 14 to 16 gauge stranded wire should be used. It is suggested that these wires be labeled S1 and S23. The terminal blocks are designed to use terminal lugs on all wires and the screws should be torqued to 9.6 in. lbs.

Note: Any relay closure can be used to start and stop this generator. As long as the contact stays closed the engine generator set will continue to run. Once the relay is opened the unit will shut down and remain in the standby mode until the remote start relay is closed again.

F - CUSTOMER REMOTE STOP LIGHT - This set of terminals can be used to light a 12 volt remote light to indicate that the unit is in emergency stop. The terminal blocks are designed to use terminal lugs on all wires and the screws should be torqued to 9.6 in. lbs.

G - REMOTE DISPLAY PANEL INTERFACE TERMINALS -

These interface terminals are prewired to allow for the connection of a Basler RDP-110 remote display. This display allows for the remote annunciation of alarms at a location such as a nurses station or a control room. This display is used to meet the remote annunciation requirements of NFPA 110 standards.

NOTE:

This feature must be turned on at the time the manufacture.

When used with the RDP-110 two twisted pairs of 20 AWG wire may be used for distances of up to 4000 feet. The terminal blocks are designed to use terminal lugs on all wires and the screws should be torqued to 9.6 in. lbs.

DC Interconnections to the Automatic Transfer Switch

Two control wires are required between the A.T.S. panel and the

generator control terminal box. Depending on the distance, 14 to 16 gauge stranded wire should be used. These wires should be labeled S1 and S23.

***** **WARNING** *****

Be sure Engine Generator is in the "OFF" position before you make any DC interconnections.

***** **CAUTION** *****

Never run the AC and DC wiring in the same conduit.

Zenith ATS

The terminal markings in the Zenith ATS are marked "X1" and "X2". The wire labeled "Start 1" is routed to start contact "X1" and

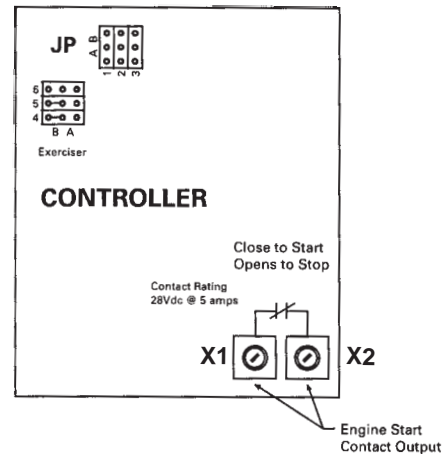

the wire labeled "Start 23" is routed to start contact "X2"

ASCO 165 UL SWITCH

Your DC connection points in the ASCO 165 ATS are

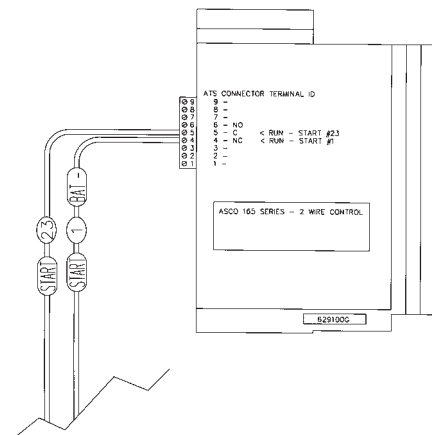

terminals "4" and "5" on the interface terminal bloc

ASCO 300 UL SWITCH

Your DC connection points in the ASCO 300 ATS are terminals "14" and "15". Depending on the size of the switch they are located in different locations. See next page:

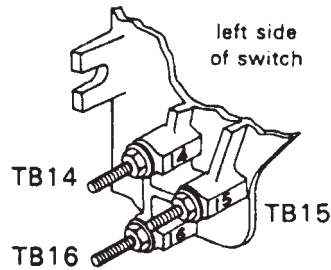
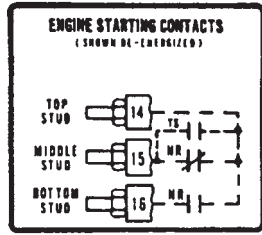

Engine starting contact label and location for 30 - 200 amp switches.

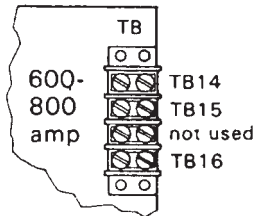
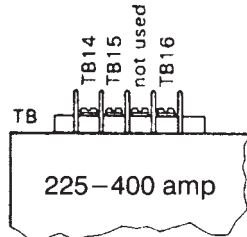

INITIAL START UP

**** WARNING ****

EQUIPMENT DAMAGE - DO NOT jump start these engine generator sets. Starting these units on a low battery or jump starting them will cause damage to the engine control module.

Use the following check list to verify correct installation before starting the engine:

1. Engine oil. Fill as required with proper grade/qty.
2. Engine coolant. Fill as required with proper mixture.
3. Unit mounting base properly bolted down.
4. Clearance for service and maintenance on all sides.
5. Proper fuel line material and size.
6. All fuel line connections tight.
7. Fuel line protected and a moisture trap installed (may be required for N.G.).
8. Correct LP/NG pressure 4-6 Oz. (7-11" Wc).
9. Battery connections clean and tight.
10. Battery fully charged.
11. All AC and DC wiring installed and properly protected.

After completing the above checklist, the engine-generator set is ready for the initial start-up test.

PROCEDURE

Depress the "RUN" push-button on the front of the DGC. The engine-generator will crank and start automatically. If the engine fails to start, depress the "stop" push-button and correct the trouble before proceeding.

With the engine running smoothly check the no load voltage and frequency on the digital display. The voltage should be 208/240/480 AC depending on which model you have and a frequency of 59.5 To 60.5 hertz (Hz).

If you have the proper voltage at the generator the next step is to check the voltage at the generator terminals in the Automatic Transfer Switch. The voltage between the G1 and the G3 terminals should be the same as it was on the generator front panel. The voltage should also be checked between the hot terminals (G1 and G3) and the G-N to be certain of a balanced voltage output and a solid neutral connection. The voltage between G1 and G-N should be about 120 volts AC (277 on 480 units). The same approximate voltage should be found between terminals G3 and G-N (120 volts AC).

On three phase panels the G2 voltage level should also be checked. **ON 240 VOLT (DELTA) SYSTEMS BE SURE YOU KNOW WHERE THE HIGH VOLTAGE "WILD" LEG IS. IT MUST BE IN THE SAME LOCATION ON THE LINE SIDE AS IT IS ON THE GENERATOR SIDE.** (i.e. if it's on L-3 on the line side it must be on G-3 on the generator side.

** Notice **

If for any reason during the check out procedure the voltage and frequency are not correct, depress the "OFF" push-button and correct the trouble before proceeding.

After verifying that the voltage and frequency are correct, depress the "OFF" push-button. The unit should shut off with no time delay. You are now ready to test the automatic start function.

To test the Automatic Transfer Switches follow the instruction in the operators manual you received with your transfer switch. If you get a fault light during the initial start up or prior to start up it is most likely a false warning light. Simply reset the A.T.S. and start over.

Once you have completed testing of the ATS, be sure you ALWAYS leave the system in standby mode unless servicing the unit. For standby operation, press the "AUTO" button on the front of the engine control. The green light should light up under the "AUTO" button.

SETTING THE EXERCISER CIRCUIT

For all ATS see the instruction manual shipped with the ATS for instruction on setting the exercise circuit in your ATS

TROUBLESHOOTING TABLES

UNIT WILL NOT CRANK WHEN THE POWER FAILS.

1. Digital Genset Controller not in "AUTO"
2. Transfer control switch not in "AUTOMATIC" position.
3. Incorrect wiring between transfer switch and generator.
4. Defective start stop relay in the transfer switch.
5. Circuit breaker tripped on Digital Genset Controller.
6. Defective Digital Genset Controller
7. Loose or dirty battery terminals.
8. Defective "Run/Auto" switch on generator or transfer switch.
9. Defective starter.
10. Defective start solenoid.

ENGINE WILL NOT CRANK WITH GENERATOR RUN PUSH-BUTTON DEPRESSED.

1. Battery dead.
2. DC circuit breaker for Digital Genset Controller tripped.
3. Defective Digital Genset Controller.
4. Loose or dirty battery terminals.
5. Defective "Run/Auto" switch on generator.
6. Defective starter.
7. Defective start solenoid.
8. Locked up engine genset.

ENGINE CRANKS BUT WILL NOT START

1. Improper fuel pressure being delivered to unit.
2. Fuel supply shut off.
3. Fuel tank empty.
4. Defective spark plug.
5. Defective engine ignition module.
6. Dirty air cleaner filter.
7. Defective fuel solenoid valve.
8. Low battery.
9. Defective fuel regulator

ENGINE STARTS AND THEN STOPS AND ALARM LIGHT COMES ON

1. Engine is low on oil.
2. Engine has high water temperature.
3. Engine has overspeed.
4. Engine has gone into overcrank.
5. No output from engine alternator to engage stop crank circuit.

ENGINE WILL NOT COME UP TO SPEED AFTER IT STARTS

1. Insufficient fuel volume getting to the unit.
 - a. Too small of fuel line.
 - b. Fuel pressure too low/high.
2. Fuel load block needs to be adjusted.
3. Governor is defective.
4. AC short in generator components.

ATS PANEL WILL NOT TRANSFER TO EMERGENCY SUPPLY (GENERATOR)

1. No AC generator output from generator.
2. Broken or defective mechanical/electrical interlocks.
3. Defective holding coil in the generator side contactor.
4. Wiring error between generator and transfer switch.
5. Defective start/stop relay

ATS PANEL WILL NOT RETRANSFER TO NORMAL POWER

1. Proper normal line power not available at line terminals in ATS panel.
2. Defective holding coil in line side contactor.
3. Broken or defective mechanical/electrical interlocks.
4. Defective start/stop relay

NO AC OUTPUT FROM GENERATOR

1. Defective diode.
2. Defective voltage regulator.
3. Defective rotor.
4. Defective stator.
5. Defective exciter rotor.
6. Defective exciter stator.
7. AC short in the output leads.
8. Defective field circuit breaker.

NG/ LP CONVERSION

**** CAUTION ****

EQUIPMENT DAMAGE - Do not make any fuel adjustments or governor adjustments until all pressure readings are in compliance with specification. See fuel pressure charts (tables 1, 2, and 3).

The engine generator sets covered in this manual are shipped for a specific fuel, either Liquid Propane (LP) vapor or Natural Gas (NG). If it should be necessary to change the type of fuel used after a unit is received, you will need to contact the WINCO Service Department at 507-357-6831. The same thing holds true if you are making a conversion to/from liquid withdrawal LP, consult the factory. Additional parts will be required for any fuel conversion .

NOTES:

1. DIMENSIONS ARE SUBJECT TO CHANGE. ALWAYS OBTAIN A CERTIFIED DRAWING FOR CONSTRUCTION PURPOSES.
2. SIX MOUNTING HOLES 5/8" DIA. ARE PROVIDED IN BOTTOM OF BASE.

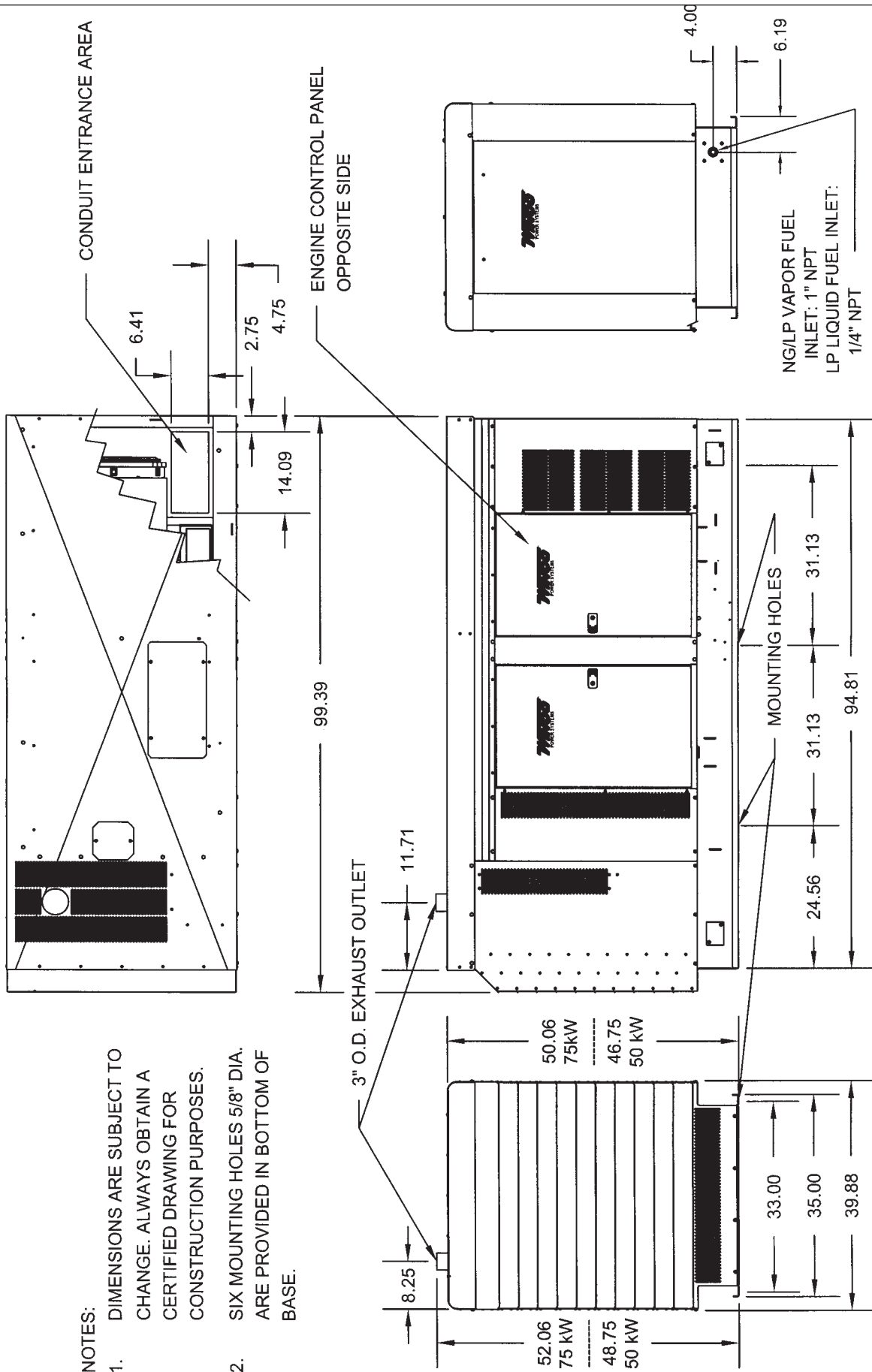

PSS50LS & 75LS OUTLINE DRAWING AND WIRING ENTRANCE

VOLTAGE REGULATOR WIRING THREE PHASE AND SINGLE PHASE

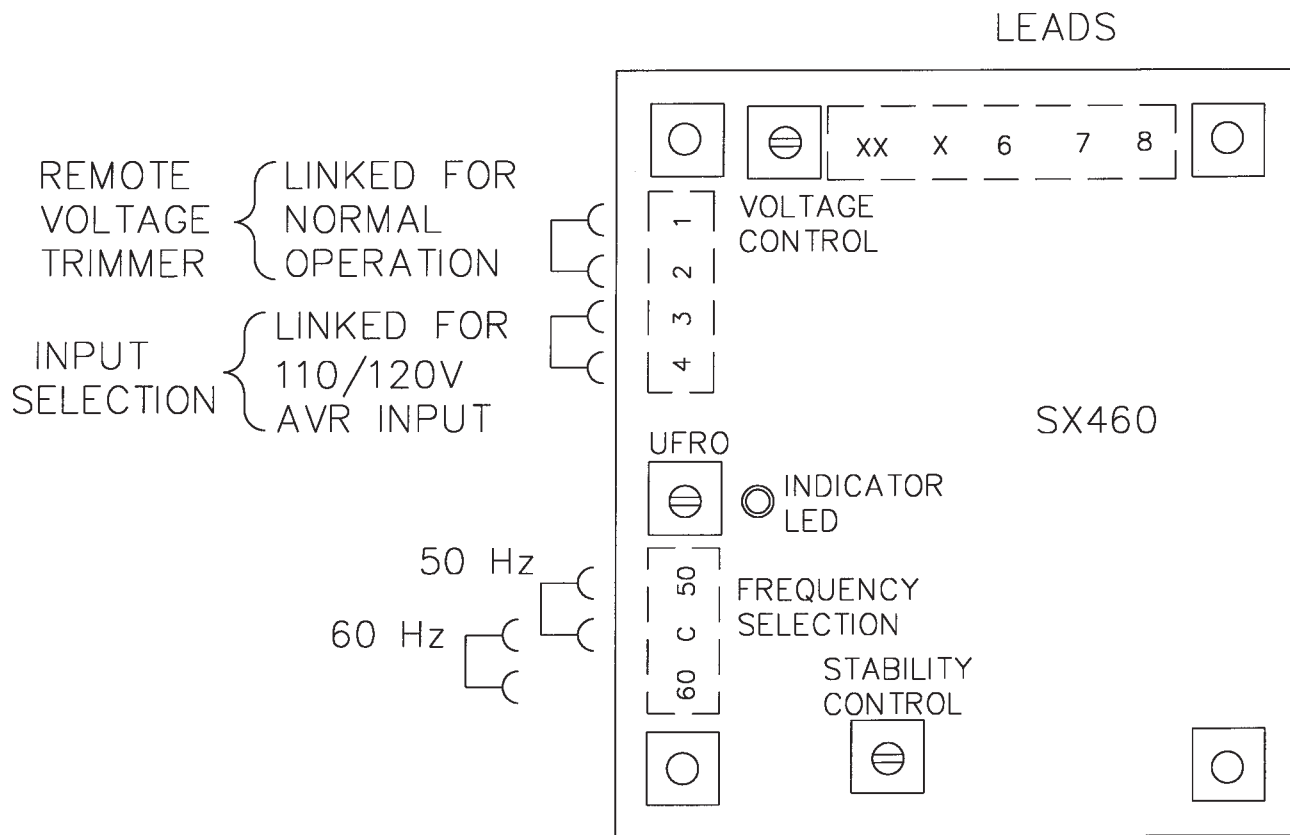

DGC-2020 WIRING DIAGRAM & ENGINE WIRING SCHEMATIC

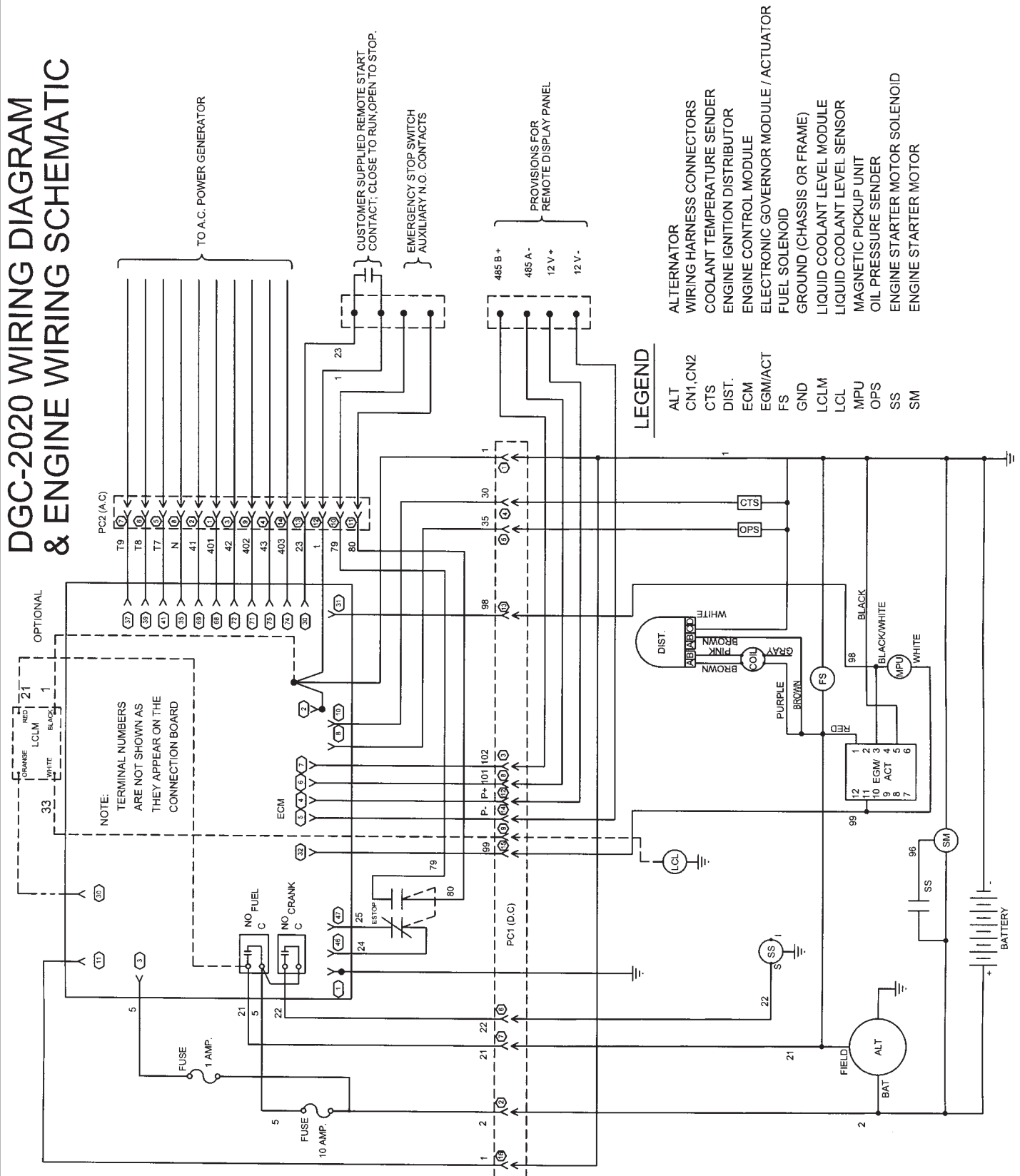

WINCO INC[®]

*A Division of **DTE** Dyna Technology Inc*

12 MONTH LIMITED WARRANTY

WINCO, Incorporated warrants to the original purchaser for 12 months or 1000 hours which ever occurs first, that goods manufactured or supplied by it will be free from defects in workmanship and material, provided such goods are installed, operated and maintained in accordance with WINCO written instructions.

WINCO's sole liability, and Purchaser's sole remedy for a failure under this warranty, shall be limited to the repair of the product. At WINCO's option, material found to be defective in material or workmanship under normal use and service will be repaired or replaced. For warranty service, return the product within 12 months or 1000 hours which ever occurs first from the date of purchase, transportation charges prepaid, to your nearest WINCO Authorized Service Center or to WINCO, Inc. at Le Center Minnesota.

THERE IS NO OTHER EXPRESS WARRANTY.

To the extent permitted by law, any and all warranties, including those of merchantability and fitness for a particular purpose, are limited to 12 months or 1000 hours which ever occurs first, from date of purchase. In no event is WINCO liable for incidental or consequential damages.

Note: Some states do not allow limitation on the duration of implied warranty and some states do not allow the exclusion or limitation of incidental or consequential damages, so the above limitations may not apply in every instance. This warranty gives you specific legal rights which may vary from state to state.

WINCO reserves the right to change or improve its products without incurring any obligations to make such changes or improvement on products purchased previously.

EXCLUSIONS:

WINCO does not warrant Engines. Engines are covered exclusively by the warranties of their respective manufacturers, see enclosed warranties.

WINCO does not warrant Batteries, or Other Component Parts that are warranted by their respective manufacturers.

WINCO does not warrant modifications or alterations which were not made by WINCO, Inc.

WINCO does not warrant products which have been subjected to misuse and/or negligence or have been involved in an accident.

WINCO INC[®]
*A Division of **DTE** Dyna Technology Inc*
225 South Cordova
Le Center Mn 50657
507-357-6831
www.wincogen.com