

**PSS50LS/D
PSS75LS/B**

**INSTALLATION AND
OPERATIONS MANUAL
for UNITS EQUIPPED
WITH BASLER DIGITAL
GENSET CONTROLS**

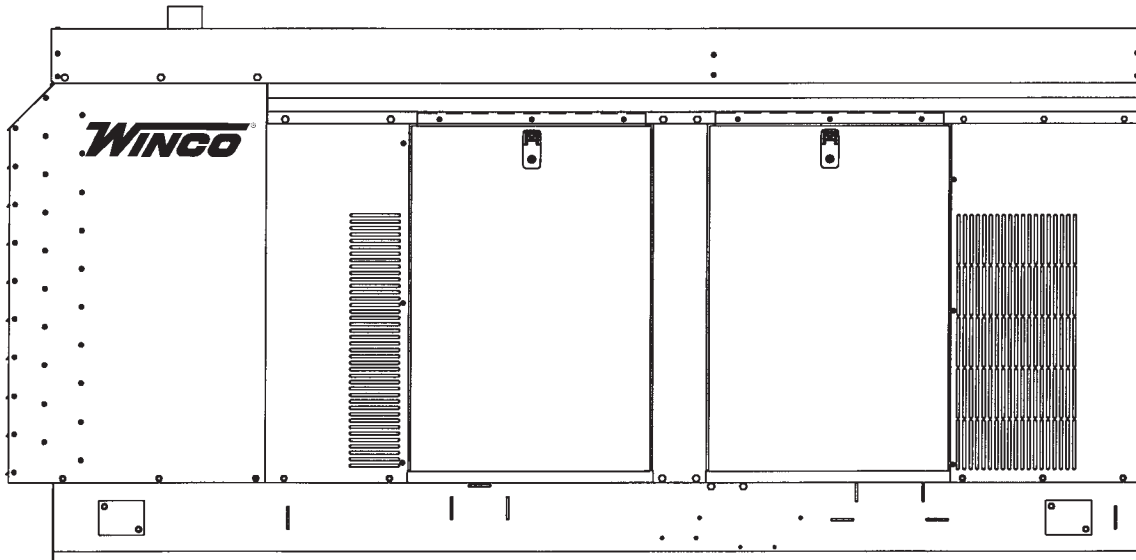

Engine Generator Set

Read and understand all instructions in the manual before starting and operating the generator set.

USING THIS MANUAL

Congratulations on your choice of a Winco generator set. You have selected a high-quality, precision-engineered generator set designed and tested to give you years of satisfactory standby service.

To get the best performance from your new engine generator set, it is important that you carefully read and follow the operating instructions in this manual.

Should you experience a problem please follow the "Things To Check" near the end of this manual. The warranty listed in this manual describes what you can expect from WINCO should you need service assistance in the future

COPY YOUR MODEL AND SERIAL NUMBER HERE

No other WINCO generator has the same serial number as yours. It is important that you record the number and other vital information here. If you should ever need to contact us on this unit it will help us to respond to your needs faster.

MODEL _____

SERIAL NUMBER _____

PURCHASE DATE _____

DEALER _____

TABLE OF CONTENTS

INTRODUCTION	i
GUIDE TO PRODUCT SAFETY	1
BASIC INFORMATION	2
Description	2
Specification Table	3
PREPARING THE UNIT	4
Unpacking the unit	4
ENGINE GENERATOR INSTALLATION	4
Installation	4
Fuel Line Installation	5
Fuel Pressure Tables	5
LP Liquid Withdrawal	6
Lubrication	6
Coolant	6
Battery Installation	6
Battery Charger/Bloack Heater Wiring	6
TRANSFER SWITCH INSTALLATION (NON-UL)	6
AC Electrical Connections	7
DC Electrical Connections	8
TRANSFER SWITCH INSTALLATION (UL)	8
AC Electrical Connections	8
DC Electrical Connections	8
INITIAL START-UP	9
EXERCISER CLOCK	10
TROUBLESHOOTING INFORMATION	10
LP/NG CONVERSION	11
AC WIRING - THREE PHASE	
277/480 Volt	12
120/208 Volt	12
120/240 Volt	13
AC WIRING - SINGLE PHASE	
120/240 Volt	13
VOLTAGE REGULATOR WIRING	14
DC SCHEMATIC - WIRING DIAGRAM	15
OUTLINE DRAWING	16
12 MONTH WARRANTY	17

PROPER USE AND INSTALLATION

You must be sure your new engine generator set is:

- * Properly serviced before starting
- * Operated in a well ventilated area
- * Properly exhausted and gases safely dispersed
- * Wired by a qualified electrician
- * Operated only for its designed purposes
- * Used only by operators who understand its operation
- * Properly maintained

SAFETY INFORMATION

This engine generator set has been designed and manufactured to allow safe, reliable performance. Poor maintenance, improper or careless use can result in potential deadly hazards; from electrical shock, exhaust gas asphyxiation, or fire. Please read all safety instructions carefully before installation or use. Keep these instructions handy for future reference. Take special note and follow all warnings on the unit labels and in the manuals.

ANSI SAFETY DEFINITIONS

DANGER:

*DANGER indicates an imminently hazardous situation which, if not avoided, **will** result in death or serious injury. This signal word is to be limited to the most extreme situations.*

WARNING:

*WARNING indicates a potentially hazardous situation which, if not avoided, **could** result in death or serious injury.*

CAUTION:

CAUTION indicates a potentially hazardous situation which, if not avoided, may result in minor or moderate injury. It may also be used to alert against unsafe practices.

NOTE:

CAUTION is also used on the unit labels and in this manual to indicate a situation that could result in serious damage or destruction of the equipment and possible personal injury.

1. **ELECTRIC SHOCK** - The output voltage present in this equipment can cause a fatal electric shock. This equipment must be operated by a responsible person.
 - a. Do not allow anyone to operate the generator without proper instruction.
 - b. Guard against electric shock.
 - c. Avoid contact with live terminals or receptacles.
 - d. Use extreme care if operating this unit in rain or snow.
 - e. Use only three-prong grounded receptacles and extension cords.
 - f. Be sure the unit is properly grounded to an external ground rod driven into the earth.

2. **FIRE HAZARD** - Natural gas and L.P. present a hazard of possible explosion and/or fire.
 - a. Do not smoke or use open flame near the generator set.
 - b. Keep a fire extinguisher nearby and know its proper use. Fire extinguishers rated ABC by NFPA are appropriate.
3. **DEADLY EXHAUST GAS** - Exhaust fumes from any gasoline engine contain carbon monoxide, an invisible, odorless and deadly gas that must be mixed with fresh air.
 - a. Operate only in well ventilated areas.
 - b. Never operate indoors.
 - c. Never operate the unit in such a way as to allow exhaust gases to seep back into closed rooms (i.e. through windows, walls or floors).
4. **NOISE HAZARD** - Excessive noise is not only tiring, but continual exposure can lead to loss of hearing.
 - a. Use hearing protection equipment when working around this equipment for long periods of time.
 - b. Keep your neighbors in mind when permanently installing this equipment.
5. **CLEANLINESS** - Keep the generator and surrounding area clean.
 - a. Remove all grease, ice, snow or materials that create slippery conditions around the unit.
 - b. Remove any rags or other material that could create potential fire hazards.
 - c. Carefully wipe up any gas or oil spills before starting the unit.
 - d. Never allow leaves or other flammable material to build up around the engine exhaust area.
6. **SERVICING EQUIPMENT** - All service, including the installation or replacement of service parts, **should be performed only by a qualified technician.**
 - a. Use only factory approved repair parts.
 - b. Do not work on this equipment when fatigued.
 - c. Never remove the protective guards, cover, or receptacle panels while the engine is running.
 - d. Use extreme caution when working on electrical components. High output voltages from this equipment can cause serious injury or death.
 - e. Always avoid hot mufflers, exhaust manifolds, and engine parts. They all can cause severe burns instantly.
 - f. Installing a generator set is not a "do-it-yourself" project. Consult a qualified, licensed electrician or contractor. The installation must comply with all national, state, and local codes.
 - g. Always make sure unit is disabled before placing your hands anywhere near the fan, belts, alternator or water hoses.

TESTING POLICY:

Before any generator is shipped from the factory, it is fully checked for performance. The generator is loaded to its full capacity, and the voltage, current, and frequency are carefully checked.

Rated output of generators is based on engineering tests of typical units, and is subject to, and limited by, the temperature, altitude, fuel, and other conditions specified by the manufacturer of the applicable engines.

INTRODUCTION AND DESCRIPTION

The package standby engine generator set includes all items necessary for a completely automatic standby power system as standard equipment. The entire package is then tested to insure proper operation of all components and the total system performance and reliability.

DESCRIPTION

This package power system is designed to automatically provide standby power to unattended loads during electrical outages. Upon an interruption of normal electrical service this package power systems electrical control circuits will automatically start the engine. The generator will produce electrical power and the Automatic Transfer Switch (A.T.S.) will automatically transfer the electrical loads to the engine-generator set. Upon restoration of normal electrical service the A.T.S. will sense return of the normal commercial power and retransfer the load back to normal commercial power source. The engine control circuits will begin a 3 minute cool-down cycle, after which the fuel supply will be shut off and the engine ignition system disabled.

These package power systems consist of two major components:

1) WINCO AUTOMATIC TRANSFER SWITCH (Non-UL model)

The table below shows the different Automatic Switch sizes typically used with each unit.

MODEL	VOLTAGE	CONTACTOR RATING	
		LINE	GENERATOR
PSS50LS-3	120/240	230	230
PSS50LS-4	120/208	230	230
PSS50LS-17	120/240	230	230
PSS50LS-18	277/480	*	*
PSS75LS-3	120/240	400	320
PSS75LS-4	120/208	400	320
PSS75LS-17	120/240	400	320
PSS75LS-18	277/480	*	*

*Special order UL Transfer Switches

These Automatic Transfer Switches (A.T.S.) are wall mount switches designed for inside installation. The A.T.S. consists of a line side contactor and a generator side contactor. The contactors are both electrically and mechanically interlocked. A seven day electronic exerciser clock is installed in the A.T.S. as standard equipment. The A.T.S. also contains the power failure sensing circuitry necessary to send a start/stop signal to the engine generator set.

2) ENGINE/GENERATOR

PSS50LS- The engine generator set consists of a GM 5.7L V-8 industrial, liquid cooled engine equipped to run on L.P./N.G. fuel. The engine operates at 1800 rpm and frequency regulation is maintained by the electronic governor within .5 cycles variation, from no load to rated load. The 50,000 watt (50kW) generator is a single bearing, direct drive, rotating field design. The generator is connected to the engine flywheel via flexible drive disks. The engine generator is mounted in a drip proof enclosure for outside installation. Connection boxes are provided to all customer connections (both AC output and DC control). A **customer supplied** 12 Volt, 650 CCA (BCI group 24) battery is required to complete the installation. Engine operation is controlled by an Digital Genset Controller (DGC) mounted in the engine generator enclosure.

PSS75LS - The engine generator set consists of a GM 5.7L , Turbo charged V-8 industrial, liquid cooled engine equipped to run on L.P./N.G. fuel. The engine operates at 1800 rpm and frequency regulation is maintained by the engine governor within .5 cycles variation, no load to rated load. The 75,000 watt (75kW) generator is a single bearing, direct drive, rotating field design. The generator is connected to the engine flywheel via flexible drive disks. The engine generator is mounted in a drip proof enclosure for outside installation. Connection boxes are provided to all customer connections (both AC output and DC control). A **customer supplied** 12 Volt, 650 CCA (BCI group 24) battery is required to complete the installation. Engine operation is controlled by an Digital Genset Controller (DGC) mounted in the engine generator enclosure.

** NOTICE **

These units will automatically transfer if a power outage occurs while running in an exercise mode.

Digital Genset Controller

The Digital Genset Controller (DGC) is a programmable engine control module utilizing the latest technology in digital control. The DCGs in these units have been programmed to meet the more sophisticated needs of today's generator users.

The following system settings have been programmed into the DCG:

Start Delay	10 Seconds
Generator Cranking Style	Cycle
Number of Cranking Cycles	3
Cycle Crank Duration	15 Seconds
Crank Disconnect	30% of Rated Speed
Cool Down Timer	5 Minutes
High Coolant Lockout	60 Seconds
Low Oil Pressure Delay	10 Seconds

The following pre-alarm and alarm setting have been programmed in the DCG:

	Pre-Alarm	Alarm
High Coolant Temp (Deg F)	210	230
Low Oil Pressure	25 PSI	15 PSI
Overspeed	N/A	115%

Battery Overvoltage	15 VDC	N/A
Low Battery Voltage	10 VDC	N/A
Weak Battery Voltage	7.5 VDC	N/A
Coolant Temperature Sender Failure		Enabled
Oil Pressure Sender Failure		Enabled
Magnetic Pickup Failure		Enabled

During normal operation the DGC will continuously display the engine oil pressure, coolant temperature and the battery voltage reading. By pressing the "**Phase Toggle**" push-button you can toggle through the different phases checking the generator output and amperage reading on each phase.

The DGC has three operational push-buttons. You can tell which position has been activated by the LEDs positioned just under the push-buttons:

RUN - Will start the unit locally at the engine generator set and allow you to perform any necessary checks prior to connecting your loads.

STOP - Will disable the engine-generator set making it safe to perform routine maintenance.

AUTO - Will allow the unit to be started from a remote location. This is the position you will use in conjunction with an Automatic Transfer Switch. This is also the push-button you depress to leave the unit in "Standby Mode"

There are three additional LED lights on the panel:

NOT IN AUTO - Indicates that the engine generator set has not been left in the "AUTO" mode and will not start if there is a line power failure.

ALARM - This red LED lights continuously during alarm conditions and flashes during pre-alarm conditions.

SUPPLYING LOAD - Indicates the generator is supplying more than 2% of rated current to whatever is connected to it. In such cases you should not shut the unit down for routine maintenance or you will disrupt your loads.

There are seven additional push-buttons on this control panel, only two of them should routinely be used. The "**LAMP TEST**" push-button tests the DCG indicator by exercising all LCD segments and lighting all LEDs. The "**ALARM SILENCE**" push-button would reset an audio alarm if the control is equipped with one. **These controllers are not.**

The last five push-buttons, "**Raise/Scroll**", "**Lower/Scroll**", "**Select/Enter**", "**Previous**", and "**Display Toggle**", are not used during normal operation. These push-buttons allow the service personnel to gain access to some of the programming and change it in the field. **PLEASE NOTE OPENING UP THE PROGRAMMING VIA THESE PUSH-BUTTONS AND ENTERING AN IMPROPER CODE CAN DISABLE YOUR GENERATOR.** If you should push one of these push-buttons by mistake and get the programming opened up, back out of it by depressing the display toggle. If it should become necessary to change the baseline setting programmed into this controller please contact the WINCO Inc. Service Department at 507-357-6831 for assistance.

SPECIFICATIONS

GENERATOR

MODEL	WATTS	VOLTS	AMP	HZ	PH	RPM
PSS50LS	50,000	120/240	208*	60	1	1800
PSS50LS-4	50,000	120/208	151*	60	3	1800
PSS50LS-17	50,000	120/240	174*	60	3	1800
PSS50LS-18	50,000	277/480	75*	60	3	1800
PSS75LS	75,000	120/240	312**	60	1	1800
PSS75LS-4	75,000	120/208	225**	60	3	1800
PSS75LS-17	75,000	120/240	261**	60	3	1800
PSS75LS-18	75,000	277/480	113**	60	3	1800

*Derate 11% for Natural Gas operation. Derate 3.5% per 1000 feet elevation above sea level.

**Derate 7% for LP operation. Derate 3.5% per 1000 feet elevation above sea level.

FUEL CONSUMPTION

MODEL	NG (1,000 BTU/CU FT)		L.P. VAPOR (2,520 BTU/CU FT)			
	CF/HR	BTU/HR	#/HR	GAL/HR	CF/HR	BTU/HR
PSS50LS	725	725,000	36.0	8.5	300	756,000
PSS75LS	1000	1,000,000	43.2	10.2	360	907,200

L.P. TANK SIZING

Minimum required L.P. Tank size for L.P. Vapor withdrawal operating at various outside temperatures given in degrees Fahrenheit (Celsius)

TANK TEMPERATURE

MODEL	60 F(16 C)	30 F(0 C)	0 F(-18 C)	-20 F(-29 C)
PSS50LS	500 Gal	1000 Gal	1500 Gal*	5000 Gal*
PSS75LS	500 Gal.	1000 Gal.	2000 Gal.*	5000 Gal.*

*Recommend liquid withdrawal at these temperatures.

ENGINE SPECIFICATIONS:

Refer to engine operating and maintenance instructions

** NOTICE **

Regarding Engines - This manual covers the generator portion of these units. See the separate engine instruction manual for engine-related problems, detailed engine information and engine warranty.

** CAUTION **

EQUIPMENT DAMAGE - Be sure to check the engine oil level frequently as specified in the engine manual.

The engine manufacturer has established an excellent world-wide engine service organization; engine service is available from a nearby authorized dealer or distributor; check the Yellow Pages of the telephone directory under "engines," or ask the dealer from whom you purchased the power plant.

The rated power of each engine-generator is limited by the temperature, altitude and all other ambient conditions specified by the engine manufacturer. Engine power will decrease 3-1/2% for each 1000 ft. above sea level, and will decrease an additional 1% for each 10 degrees Fahrenheit above 60 degrees Fahrenheit.

UNPACKING INSTRUCTIONS

** NOTICE **

When unpacking the generator set, be sure to inspect it carefully for freight loss or damage. If loss or damage is noted at the time of delivery, require that the person making the delivery make note of the loss or damage on the freight bill, or affix his signature under the consignee's memo of the loss or damage. Contact the carrier for claim procedures.

When loss or damage is noted after delivery, segregate the damaged material, and contact the carrier for claim procedures.

"Concealed Damage" is understood to mean damage to the contents of a package which is not in evidence at the time of delivery by the carrier, but which is discovered later. The carrier or carriers are responsible for merchandise lost or damaged in transit. The title to goods rests with the consignee when generators are shipped FOB factory, and only the consignee can legally file a claim.

**** CAUTION ****

EQUIPMENT DAMAGE - These units are shipped with oil, and a 50/50 mix of coolant. Be sure to check all fluid levels before operating. See engine manufacturer's instruction manual for recommended oil requirements before initial starting.

UNPACKING:

1. Carefully remove the carton.
2. After inspecting the engine-generator for external physical damage, check for the following items packed inside the carton:
 - a. Owner's manual and wiring diagram.
 - b. Engine manufacturer's instruction manual.
3. Remove main frame hold down bolts, (4).
4. Unit can now be lifted from shipping rails.

INSTALLATION

General Information

**** WARNING ****

PERSONAL INJURY - Before proceeding with the installation, be sure the operation selector switch is in the "stop" position.

These engine generator sets are available as an unhooded, skid mounted unit for indoor installation or a skid mounted unit with a standard or accoustical housing for outdoor installation. All versions of these units must be bolted solidly to a concrete pad. The transfer switch is mounted next to your distribution panel inside the building. Consult a qualified, licensed electrician or contractor to install and wire the transfer switch. The installation must comply with all national, state, and local codes.

**** CAUTION ****

EQUIPMENT DAMAGE - These units must be mounted on a solid concrete pad to prevent air from exiting under the unit. Allowing air to exit under the unit may cause the unit to overheat from lack of proper air flow.

Before beginning the installation process recheck the rating of the generator set and its transfer switch rating. Be certain they can handle the intended load and are compatible with the entrance voltage, phase and current ratings. Plans for installation should be prepared with proper attention to mechanical and electrical engineering detail to assure a satisfactory system installation. The information in this manual is offered only as a guide to finalizing your installation plans. For full service switching the A.T.S. should have a fusible disconnect (circuit breaker) installed before the switch to protect the contacts.

ENGINE GENERATOR SET MOUNTING

The unit's main frame should be bolted solidly to a 4 to 6 inch thick cement pad. The engine-generator is mounted on a sub-frame which is attached with special shock mounts to the main frame. This allows the engine-generator free movement without affecting the control panel which is mounted on the main frame.

Do not shock mount the main frame. Engine vibration will be transmitted to the control panel causing erroneous start/stop cycles and premature control failure.

The unit should be mounted to allow for ample working room around it. A general rule to follow is three (3) feet of clearance on all sides.

FUEL INSTALLATION

The fuel supply should be as close as possible to the engine. This will reduce the installation cost of fuel runs. The information in this manual is offered to assist you in providing the proper fuel for your engine. However, this information is only provided to inform you of the engine's requirements and assist in making you aware of the decisions you must make. In no case should the instructions or information provided be interpreted to conflict with any local, state or national codes. If in doubt, always consult your local fire marshal or gas supplier.

**** WARNING ****

FIRE HAZARD - All fuel runs should be installed by a licensed fuel supplier.

Connect the fuel supply to the inlet of the fuel solenoid (see table for recommended line size). The pressure at the secondary demand regulator must be four to six ounces psi (per square inch) or 7 to 11 inches W.C. (Water column) for vapor withdrawal units. On units equipped with liquid withdrawal fuel systems full tank pressure is plumbed to the fuellock strainer mounted on the generator rails. The fuel converter mounted on the unit will handle both vaporization of the fuel and pressure reduction.

INSTALLING THE FUEL LINE

** NOTICE **

The engine generator sets are properly adjusted before they leave the factory for a specific fuel, either NG (natural gas), LP (liquid propane vapor) or LPG (liquid withdrawal propane). This fuel type is noted in your model number. If it becomes necessary to change the fuel type in the field see information on page 10.

Line Size (vapor system)

Unit location will determine the size of fuel line that is required to supply the engine with a constant fuel pressure. Refer to the tables below for fuel line size, fuel consumption and recommended tank size. For distances of 25 feet and over, a two regulator fuel system is recommended. This is accomplished by installing a primary regulator at the tank which will reduce the tank pressure down to 10 to 15 lbs. A secondary regulator is installed to further reduce the fuel pressure to the required six (6) oz operating pressure. This secondary regulator must be at least 10 feet from the engine generator set. Any closer installation will require a larger line be installed to provide a fuel reservoir. If this is not done, the demand regulator on the unit and the pressure regulator in the fuel line will interfere with each other. When this two (2) stage regulator system is used, a fuel line size of 3/4 to 1 inch is generally adequate for distances up to 300 feet from the primary to the secondary regulator. (Consult your local fuel supplier for your exact requirements). The appropriate line size from the table below is then installed from the secondary regulator to the generator set.

**** WARNING ****

PERSONAL DANGER - Do not use galvanized pipe in fuel line runs. The galvanized coating can become eroded and flake off, causing possible obstructions in the regulator or fuel valve. The results could range from inoperative engine start to hazardous fuel leaks.

Size of pipe normally required for generators operating on NATURAL/LP gas:

	up to 25 feet*	over 25 feet*
PSS50LS	1" pipe	not recommended
PSS75LS	1" pipe	use a two regulator system

* Allow an additional 3 feet for each standard elbow.

Do not use 'street ells' (restrictive).

**** CAUTION ****

EQUIPMENT DAMAGE - Be careful when sealing gas line joints. Excessive sealing compound can be drawn into the solenoid, regulator or carburetor causing an engine malfunction.

FUEL PRESSURE (vapor system)

Correct fuel pressure cannot be stressed enough. The most common cause for inoperative systems is an inadequate or incorrect fuel pressure. Performance of the engine is in direct relation to the correctness of the fuel system. Shown below is a block diagram of a typical L.P. or N.G. Installation.

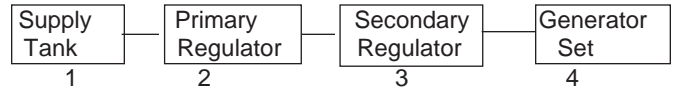

TWO (2) REGULATOR FUEL SYSTEM

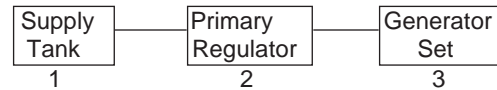

SINGLE REGULATOR FUEL SYSTEM

Reference numbers 1 through 3 in the block diagrams above are fuel lines supplied by customer.

Reference number 4 is the engine generator set.

Below is a table of the fuel pressure readings at each reference in the system.

Fuel Pressure Table

Single Regulator (L.P. Vapor only)

	1	2	3
UNIT OFF	TANK PSI	7-11 in 4-6 oz	7-11 in 4-6 oz
STARTING	TANK PSI	7-11 in 4-6 oz	7-11 in 4-6 oz
NO LOAD	TANK PSI	7-11 in 4-6 oz	7-11 in 4-6 oz
FULL LOAD	TANK PSI	7-11 in 4-6 oz	7-11 in 4-6 oz

Two (2) Regulator System (L.P. Vapor only)

	1	2	3	4
UNIT OFF	TANK PSI	10-15 lbs	7-11 in 4-6 oz	7-11 in 4-6oz
STARTING	TANK PSI	10-15 lbs	7-11 in 4-6 oz	7-11 in 4-6 oz
NO LOAD	TANK PSI	10-15 lbs	7-11 in 4-6 oz	7-11 in 4-6 oz
FULL LOAD	TANK PSI	10-15 lbs	7-11 in 4-6 oz	7-11 in 4-6 oz

Natural Gas

	1	3	4
UNIT OFF	LINE PSI	7-11 in 4-6 oz	7-11 in 4-6 oz
STARTING	LINE PSI	7-11 in 4-6 oz	7-11 in 4-6 oz
NO LOAD	LINE PSI	7-11 in 4-6 oz	7-11 in 4-6 oz
FULL LOAD	LINE PSI	7-11 in. 4-6 oz	7-11 in 4-6 oz

Notice the preceding tables give two (2) different units of measuring fuel pressure. The first is with a pressure gauge calibrated in ounces per square inch. The second and most accurate is the use of a simple water manometer. A manometer is calibrated in inches of water column.

LP LIQUID WITHDRAWAL SYSTEMS

When installing a unit equipped the LP liquid withdrawal a primary regulator is not required on the supply tank. The supply line is connected to a liquid withdrawal valve on the supply tank and run directly to the fuellock strainer mounted on the engine generator set. Normally a 3/8 inch copper line is acceptable for this type of fuel installation. You must be sure that the valve you have connected to on the supply tank is in fact a liquid supply valve and has a drop tube inside the tank that is pulling fuel from the bottom of the supply tank. Before starting the unit you must confirm that you have a good liquid supply at the unit. **Engine generator sets equipped for liquid withdrawal will not run properly when supplied with high pressure vapor fuel.**

LUBRICATION

Before starting the engine, check the oil level in the crankcase. If it is low, refill to the full mark with the proper weight/grade of oil as recommended by the engine manufacturer's maintenance instructions. The necessity of using the correct oil, and keeping the crankcase full cannot be over emphasized. Failure to use the proper oil and keep the crankcase properly filled will cause excessive engine wear and shorten its useful life.

COOLANT

Before starting the engine, check the coolant level in radiator. If it is low, refill as specified in the engine manufacturer's maintenance instructions. The radiator should be filled to about 1 inch below the filler neck. For additional information on engine coolant requirements see engine manufacturer's maintenance instructions.

INSTALLING THE BATTERY

****** CAUTION ******

EQUIPMENT DAMAGE - In the following battery installation procedure, check to be sure the selector switch remains in the "stop" position.

A customer supplied twelve-volt BCI group 24 battery rated 650 CCA (minimum) is required to complete the installation. Install the highest CCA rated battery available for best cold weather starting performance.

******WARNING******

EQUIPMENT DAMAGE - Always connect the positive battery cable first and the negative cable last. When disconnecting a battery always disconnect the negative cable first and the positive cable last. Failure to follow these steps can cause arcing at the battery post which can cause damage to both the engine and the engine control module.

Observe polarities: Connect the positive (+) battery terminal to the (+) cable from the control panel; the negative (-) battery terminal is connected to the negative cable (ground) from the engine generator assembly.

NOTE: Always make sure that a new battery is fully charged before installing it on a generator set. Failure to do so can cause damage to the engine control module in the generator set.

All connections must be clean and tight. Check the electrolyte (fluid) in the battery periodically to be sure it is above the plates. Never allow the battery to remain in a discharged condition.

CONNECTING THE BATTERY CHARGER & BLOCKHEATER

A two-stage battery tender is provided on all PSS series generators. This battery tender charges at a rate of 750 mA until the battery is fully charged and then automatically switches to a 13.2 VDC float charger. The charger has an indicator light on it, red indicates it is charging, and green indicates it is in the storage mode (float charge). This charger is mounted on the engine generator set just below the engine control panel.

**** NOTICE ****

The trickle charger is not intended to recharge a battery which has become completely discharged. It is designed to produce just enough current to maintain a fully charged battery.

This battery tender requires a circuit breaker protected AC circuit from your distribution panel be run out to the engine generator set. These AC wires can be run in the same conduit as the other AC leads from the generator. It is suggested that this circuit be fused for 15 amps, then both the battery charger and the block heater can be connected to the same circuit. A 120 volt duplex receptacle is mounted on the generator just below the engine control panel, the battery tender is shipped already plugged into the receptacle.

The engine frost plug heater has been prewired with a 120 volt plug which can be plugged into the other side of the duplex receptacle after wiring 120 volt power feed to the receptacle. The frost plug heater has been prewired through a temperature sensor which will turn the heater on when the air temperature drops to 22 degrees F. and off when the air temperature reaches 30 Degrees F.

MOUNTING THE AUTOMATIC TRANSFER SWITCH (WINCO Non-UL only)

The automatic transfer switch (A.T.S.) connects the load (lights, furnace, outlets, etc.) to the normal power line. When normal power fails, the A.T.S. starts the engine generator set, disconnects the power line and then connects the load to the standby generator set. When normal power is restored, the automatic switch retransfers the electrical load to the normal service and stops the engine. The A.T.S. panel should be mounted as close to the distribution panel as possible.

FIGURE 5

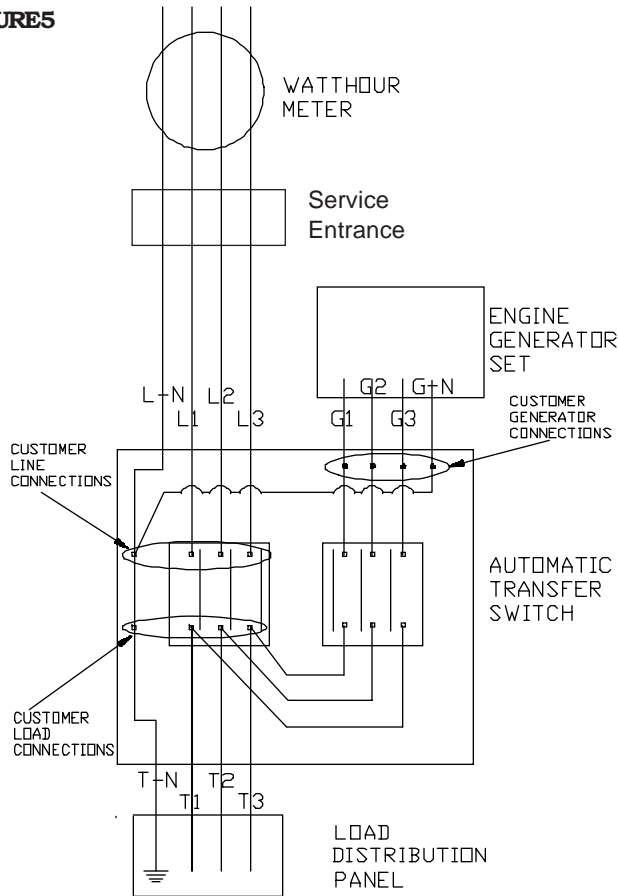

Three phase unit shown, for single phase wiring disregard L-2, T-2, G-2.

******* WARNING *******

FIRE HAZARD - All wiring must be done by a licensed electrician, and must conform to the national electrical code and comply with all state and local codes and regulations. Check with the local authorities before proceeding!

PSS50LS - The Automatic Transfer Switch typically shipped with the PSS50LS system has a 230 Amp line side contactor installed to handle your normal power needs and a 230 Amp generator side contactor to handle the emergency generator output. Before installing the A.T.S. you must first ensure that the 230 Amp line side contactor will be sufficient to handle your complete service. See Figure 5. (i.e. the main line breaker must not be larger than 230 Amps) If you have 250, 300 Amp or larger system, you will not be able to transfer the complete electrical system. In this case it will be necessary to install a secondary emergency distribution panel or purchase a larger transfer switch.

PSS75LS - The Automatic Transfer Switch typically shipped with the PSS75LS system has a 400 Amp line side contactor installed to handle your normal power needs and a 320 Amp generator side contactor to handle the emergency generator output. Before installing the A.T.S. you must first ensure that the 400 Amp line side contactor will be sufficient to handle your complete service. See Figure 5. (i.e. the main line breaker must not be larger than 400 Amps) If you have 500, 600 Amp or larger system, you will

not be able to transfer the complete electrical system. In this case it will be necessary to install a secondary emergency distribution panel or purchase a larger transfer switch.

******* WARNING *******

PERSONAL INJURY - Be certain the operation selector switch on the front of the A.T.S. Control is in the "stop" position and the main power switch "off". For your own protection, verify these important safety precautions yourself with reliable instruments before proceeding.

A.C. ELECTRICAL CONNECTIONS WINCO Non-UL Only

Single Phase

The standby generator terminals in the A.T.S. are marked "GENERATOR - G1, G-N, G3". The "hot" leads G1 and G3 wire directly to the top lugs on the generator side contactor, terminals G1 and G3. The G-N connection is made to the lug on the standoff just to the right of the generator side contactor.

The line terminals in the A.T.S. are marked "LINE - L1, L-N, L3". The "hot" leads L1 and L3 will wire directly to the top lugs on the line side contactor. The L-N connection will be made on the stand-off just to the left of the line side contactor.

The load terminals in the A.T.S. are marked "LOAD - T1, T-N, T3". The "hot" leads T1 and T3 will wire directly to the lower lugs on the line side contactor. Jumper leads have already been installed between the lower lugs on the line side and the lower lugs on the generator side contactors. The T-N connection will be made on the stand-off just to the left of the contactor.

An equipment grounding lug is provided just above the T-N connection for your use in grounding the transfer switch.

Three Phase

The standby generator terminals in the A.T.S. are marked "GENERATOR - G1, G2, G3 and G-N". The "hot" leads G1 G2 and G3 wire directly to the generator side contactor, terminals G1, G2 and G3. The G-N connection is made to the lug on the standoff just to the right of the generator side contactor.

The line terminals in the A.T.S. are marked "LINE - L1, L2, L3 and L-N". The "hot" leads L1, L2 and L3 will wire directly to the top lugs on the line side contactor. The L-N connection will be made on the standoff just to the left of the contactor.

The load terminals in the A.T.S. are marked "LOAD - T1, T2, T3 and T-N". The "hot" leads T1, T2 and T3 will wire directly to the lower lugs on the line side contactor. Jumper leads have already been installed between the lower lugs on the line side and the lower lugs on the generator side contactors. The T-N connection will be made on the standoff just to the left of the contactor.

An equipment grounding lug is provided just above the T-N connection for your use in grounding the transfer switch.

All the neutral leads (G-N, L-N and T-N) must be carried through the A.T.S. These leads are all bonded together within the A.T.S. and are bonded to GROUND at one common point. If your system requires an isolated neutral, this neutral to ground bond can be isolated by removing the copper strap located between the LINE terminal L-N and the ground lug in the panel. This action, along with lifting the Neutral to Ground bond in the generator connection cabinet, will effectively change this unit to a fully isolated neutral system.

The generator output leads in the generator connection box follow the same marking pattern. i.e. G1, G-N and G3 on the single phase and G1, G2, G3 and G-N on the three phase units.

******* WARNING *******

EQUIPMENT DAMAGE - When installing a Three Phase 240 volt system be sure you know which lead is the high voltage "wild" leg (208Volt line to neutral). The generator normally carries the high voltage on the G3 lead.

The load current carrying wires (L) and (T) must be sized to handle the maximum load current without excessive voltage drop. By code, the wire must be heavy enough to handle the full current rating of the main line circuit-breaker (or fuse) in the entrance (or sub-panel) protecting the contactor switch.

A fused disconnect (circuit breaker or fuses) must be installed between the engine generator and the A.T.S. panel. Failure to install a proper fused disconnect will void any warranty on the generator end. All wiring from the engine-generator to the transfer switch must be of sufficient size to handle the appropriate fused disconnect amperage.

All wires should be installed in rigid or flexible conduit. (Knock-outs are provided in the control box).

Because of the many different types of service, feeder, and distribution equipment, no specific wiring instructions can be provided. It is recommended that only copper wire be used. In all cases it is essential that while the load is connected to the generator, there can be absolutely no feedback from the generator to the power line or the power line to the generator. When properly installed, the normal A.T.S. Control and safety systems will eliminate all paths for feedback.

To wire the automatic transfer switch into the existing wiring, first determine which circuits will be on the emergency load circuit. If the entire load is to be transferred, the transfer switch can be wired in directly after the watt-hour meter and the service entrance, providing the service entrance ampere rating is within the transfer switch's rated capability.

If only specific circuits are to be powered under emergency power failure conditions, an additional distribution panel designated "emergency distribution panel" must be installed.

All selected emergency circuits are removed from main distribution panels and installed in the emergency distribution panel. The A.T.S. is then installed between the main panel and the emergency distribution panel. Suggested circuits: freezer, refrigerator, furnace, emergency lights, sump pump, emergency outlet circuits, etc. Total running load must not exceed generator rating.

D.C. ELECTRICAL INTERCONNECTION

PSS50LS and PSS75LS

Two control wires are required between the A.T.S. panel and the generator control terminal box. Depending on the distance, 14 to 16 gauge stranded wire should be used. These wires will be labeled S1 and S23.

******* WARNING *******

Be sure both the mode switch on the Engine Generator and the mode switch in the Automatic Transfer Switch are in the "OFF" position before you make any DC interconnections.

The connections to the engine control will be made in a 2" X 4" connection box mounted on the back side of the generator control box just above the engine control. The wiring from the engine control has already been stubbed into this connection box for your convenience. The wires are labeled as follows:

Battery Negative	#1	Yellow Wire	S1
Start Signal	#23	Yellow Wire	S23

The connections in the automatic transfer switch will be made on a terminal block. This terminal block is located in the lower right hand corner on the back wall of the switch. The terminals are labeled S1, and S23.

These control wires **MUST NOT** be run in the same conduit as the AC power leads coming from the generator or the 120 volt circuit for the battery charger and block heater.

******* WARNING *******

EQUIPMENT DAMAGE - DC connections between WINCO engine generators and other makes of Automatic Transfer Switches will vary. The WINCO engine generator sets require a relay closure between Battery Negative (wire S1) and Start (wire S23) to operate. The Battery Positive is not used in the A.T.S. panels. Connecting Battery Positive in any switch can cause permanent damage to the engine control module.

WINCO UL AUTOMATIC TRANSFER SWITCHES

If you are installing a UL transfer switch, there are a couple of terminal identification changes you will have to watch for, otherwise they basically wire up the same.

The DC terminal block in the UL switch is labeled 11 & 12. Wire S1 will connect to terminal #11 and S23 will connect to terminal #12.

The normal power line connection points in the UL-ATS are labeled N1, N2 for single phase and N3 is add for three phase.

The generator connection points in the UL-ATS are labeled E1 & E2 for single phase and E3 is added for three phase. When wiring single phase from the generator to the UL-ATS, G1 connects to E1 and G3 connects to E2.

There is no neutral connection point in these switches so all three neutral leads (line neutral, generator neutral and load neutral) should be connected together and taped up. See the prints enclosed with UL-ATS panel for additional information.

**** **WARNING** ****

EQUIPMENT DAMAGE - *The UL-ATS panels are voltage sensitive. Do not attempt to use a 240 volt ATS on a 208 volt system. Doing so will cause damage to the control circuits in the ATS panel. Contact the factory if you have any concerns or questions.*

UL TRANSFER SWITCHES OTHER THAN WINCO

The WINCO engine generator set will work with almost any automatic transfer switch on the market today . Although we are switching the negative side of the start circuit, as long as the transfer switch has a set of "isolated dry" contacts for the start signal to pass through it will work. When using other transfer switch panels refer to the installation manual received with the switch for proper termination of wiring from the generator.

INITIAL START UP

**** **WARNING** ****

EQUIPMENT DAMAGE - *DO NOT jump start these engine generator sets. Starting these units on a low battery or jump starting them will cause damage to the engine control module.*

Use the following check list to verify correct installation before starting the engine:

1. Engine oil. Fill as required with proper grade/qty.
2. Engine coolant. Fill as required with proper mixture.
3. Unit mounting base properly bolted down.
4. Clearance for service and maintenance on all sides.
5. Proper fuel line material and size.
6. All fuel line connections tight.
7. Fuel line protected and a moisture trap installed (may be required for N.G.).
8. Correct LP/NG pressure 4-6 Oz. (7-11" Wc).
9. Battery connections clean and tight.
10. Battery fully charged.
11. All A.C. and D.C. wiring installed and properly protected.

After completing the above checklist, the engine-generator set is ready for the initial start-up test.

PROCEDURE

Depress the "RUN" push-button on the front of the DGC. The engine-generator will crank and start automatically. If the engine fails to start, depress the "stop" push-button and correct the trouble before proceeding.

With the engine running smoothly check the no load voltage and frequency on the digital display. The voltage should be 208/240/480 A.C. depending on which model you have and a frequency of 59.5 To 60.5 hertz (Hz). If you have the proper voltage at the generator the next step is to check the voltage at the generator terminals in the Automatic Transfer Switch. The voltage between the G1 and the G3 terminals should be the same as it was on the generator front panel. The voltage should also be checked between the hot terminals (G1 and G3) and the G-N to be certain of a balanced voltage output and a solid neutral connection. The voltage between G1 and G-N should be about 120 volts AC (277 on 480 units). The same approximate voltage should be found between terminals G3 and G-N (120 volts AC). On three phase panels the G2 voltage level should also be checked. **ON 240 VOLT (DELTA) SYSTEMS BE SURE YOU KNOW WHERE THE HIGH VOLTAGE "WILD" LEG IS. IT MUST BE IN THE SAME LOCATION ON THE LINE SIDE AS IT IS ON THE GENERATOR SIDE.** (i.e. if it's on L-3 on the line side it must be on G-3 on the generator side.

** Notice **

If for any reason during the check out procedure the voltage and frequency are not correct, depress the "STOP" push-button and correct the trouble before proceeding.

After verifying that the voltage and frequency are correct, depress the "STOP" push-button. The unit should shut off with no time delay. You are now ready to test the automatic start function.

WARNING:

If you are not utilizing a WINCO non UL A.T.S. panel, STOP here and refer to the manual received with the switch panel for the proper initial start up procedure. These procedures will vary depending on which A.T.S. panel you are using.

Depress the "AUTO" push-button. Next move the selector switch on the A.T.S. panel to the "START" position. The unit will go into a 10 second start delay and then start up. If it fails to start at this time, the DC interconnection wiring is incorrect. Now when the selector switch on the A.T.S. is moved to the "DISABLE" position the unit will go into a 5 minute cool down and then shut off. As long as line power is still applied to the transfer switch during this test period the A.T.S. will not transfer the load to the generator.

Next you need to test the complete system. To accomplish this you will have to fail the incoming line power to the A.T.S. panel. First move ATS selector switch to the automatic position and make sure the AUTO LED is still lit on the DGC, if not depress the "AUTO" push-button. Then fail the incoming power. All the loads connected to the A.T.S. should now be dead. The engine generator set will go into a 10 second start delay. At the end of the start delay the unit will start up. As soon as the engine generator set reaches operating speed the generator side contactor will close and the load will be applied to the engine generator.

Restoring the line power will cause the generator side contactor in the A.T.S. to open and the line side to close as soon as the generator side is open. This sequence is controlled by the electrical and mechanical interlocks in between the two contactors in the A.T.S. panel. These interlocks ensure that you get a

clean 'break before make' action in the transfer switch. The restoration of line power also sends a stop signal to the engine generator set. This stop signal will activate the 5 minute timer circuit and shut down the unit 5 minutes later.

This completes your installation and unit testing. ALWAYS leave the system in standby mode unless servicing the unit. For standby operation, keep **both** the generator set and transfer selector switches in the "AUTOMATIC" position.

SETTING THE EXERCISER CLOCK

Setting the current time and date.

1. Position the top right hand (RUN) slide switch to the left position.
2. Push the clock's "Day Select Button" until the clock displays a triangle under the number corresponding to the current day of the week. (Monday is day 1, Sunday is day 7)
3. Push the "Hour Select Button" until the display indicates the correct hour. Note: For PM be sure there is a "P" displayed beside the correct hour.
4. Push the "Minute Select Button" until the display indicates the correct time in minutes.
5. Position the top right hand (RUN) slide switch to the center position. The correct time and date should now be displayed.

Setting the Exerciser Program:

NOTE: The programs on this clock are grouped. i.e. 1 and 2, 3 and 4, etc. The start time is programmed on the odd number and the stop time is programmed on the even number in each program set.

1. Position the top right hand (RUN) slide switch to the right hand position.
2. Position the top left hand (AUTO) slide switch to the center position.
3. Press the "Program Select Button" until No 1 is displayed on the clock to the right of the time.
4. Push the "Day Select Button" to select the day you want the engine generator set to start up and run. Note: You can get more than one triangle displayed on the clock. If this happens just keep pressing the button and it will work back through the cycle and display only one triangle under whichever day you desire.
5. With the "Hour" and "Minute" buttons select the time of day you want the engine to start up.
6. Press the "Program Select Button" until number 2 is displayed on the clock.
7. Push the "Day Select Button" to select the day you want the engine to stop. This must be the same day you selected in step 4 above.

8. With the "Hour" and "Minute" buttons, select the time you want the engine to stop. It is recommended you let the engine run at least 15 minutes during any exercise period.

9. Position the top right hand (RUN) slide switch to the center (RUN) position.

CLOCK NOTES:

This seven day exerciser clock has seven additional program cycles available. Always keep in mind the odd number turns the unit on and the even number shuts the unit off. (i.e. (3 on, 4 off) (5 on, 6 off) etc.

The relay in the clock will not work unless the transfer switch is installed and powered up. The clock relay needs 120 volts AC to operate.

If, when you finish programming the clock, you get an EEEE on the display, it stands for error. The most common error is that the day of operation has not been properly set at each step or a program has been turned on and not turned off. i.e. programs not properly grouped 1 & 2, 3 & 4, 5 & 6, etc.

On the face of the clock is a small button marked "R". This is a reset switch. Depressing this switch will remove all programming in the clock including the time. Use a small screwdriver or the tip of a pencil to depress this button. This should be used only as a last resort.

TROUBLESHOOTING TABLES

UNIT WILL NOT CRANK WHEN THE POWER FAILS.

1. Digital Genset Controller not in "AUTO"
2. Transfer control switch not in "AUTOMATIC" position.
3. Incorrect wiring between transfer switch and generator.
4. Defective start stop relay in the transfer switch.
5. Circuit breaker tripped on Digital Genset Controller.
6. Defective Digital Genset Controller
7. Loose or dirty battery terminals.
8. Defective "Run/Auto" switch on generator or transfer switch.
9. Defective starter.
10. Defective start solenoid.

ENGINE WILL NOT CRANK WITH GENERATOR RUN PUSH-BUTTON DEPRESSED.

1. Battery dead.
2. DC circuit breaker for Digital Genset Controller tripped.
3. Defective Digital Genset Controller.
4. Loose or dirty battery terminals.
5. Defective "Run/Auto" switch on generator.
6. Defective starter.
7. Defective start solenoid.
8. Locked up engine genset.

ENGINE CRANKS BUT WILL NOT START

1. Improper fuel pressure being delivered to unit.
2. Fuel supply shut off.
3. Fuel tank empty.
4. Defective spark plug.
5. Defective engine ignition module.
6. Dirty air cleaner filter.
7. Defective fuel solenoid valve.
8. Low battery.
9. Defective fuel regulator

ENGINE STARTS AND THEN STOPS AND ALARM LIGHT COMES ON

1. Engine is low on oil.
2. Engine has high water temperature.
3. Engine has overspeed.
4. Engine has gone into overcrank.
5. No output from engine alternator to engage stop crank circuit.

ENGINE WILL NOT COME UP TO SPEED AFTER IT STARTS

1. Insufficient fuel volume getting to the unit.
 - a. Too small of fuel line.
 - b. Fuel pressure too low/high.
2. Fuel load block needs to be adjusted.
3. Governor is defective.
4. AC short in generator components.

ATS PANEL WILL NOT TRANSFER TO EMERGENCY SUPPLY (GENERATOR)

1. No AC generator output from generator.
2. Broken or defective mechanical/electrical interlocks.
3. Defective holding coil in the generator side contactor.
4. Wiring error between generator and transfer switch.
5. Defective start/stop relay

ATS PANEL WILL NOT RETRANSFER TO NORMAL POWER

1. Proper normal line power not available at line terminals in ATS panel.
2. Defective holding coil in line side contactor.
3. Broken or defective mechanical/electrical interlocks.
4. Defective start/stop relay

NO AC OUTPUT FROM GENERATOR

1. Defective diode.
2. Defective voltage regulator.
3. Defective rotor.
4. Defective stator.
5. Defective exciter rotor.
6. Defective exciter stator.
7. AC short in the output leads.
8. Defective field circuit breaker.

NG/ LP CONVERSION

****** CAUTION ******

EQUIPMENT DAMAGE - Do not make any fuel adjustments or governor adjustments until all pressure readings are in compliance with specification. See fuel pressure charts (tables 1, 2, and 3).

The engine generator sets covered in this manual are shipped for a specific fuel, either Liquid Propane (LP) vapor or Natural Gas (NG). If it should be necessary to change the type of fuel used after a unit is received, you will need to contact the WINCO Service Department at 507-357-6831. The same thing holds true if you are making a conversion to/from liquid withdrawal LP consult the factory. Additional parts will be required for any fuel conversion .

THREE PHASE AC WIRING HIGH AND LOW WYE

**THREE PHASE-HIGH WYE
277/480 VOLTS**

**THREE PHASE-LOW WYE
120/208 VOLTS**

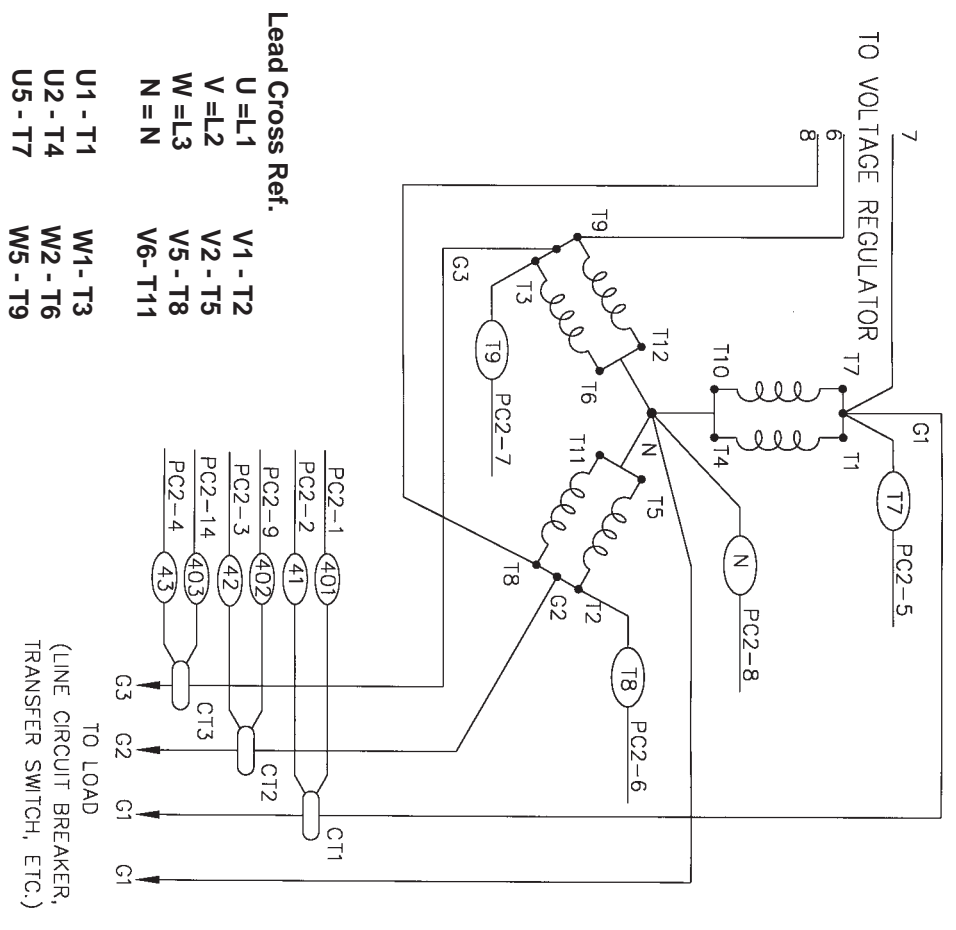
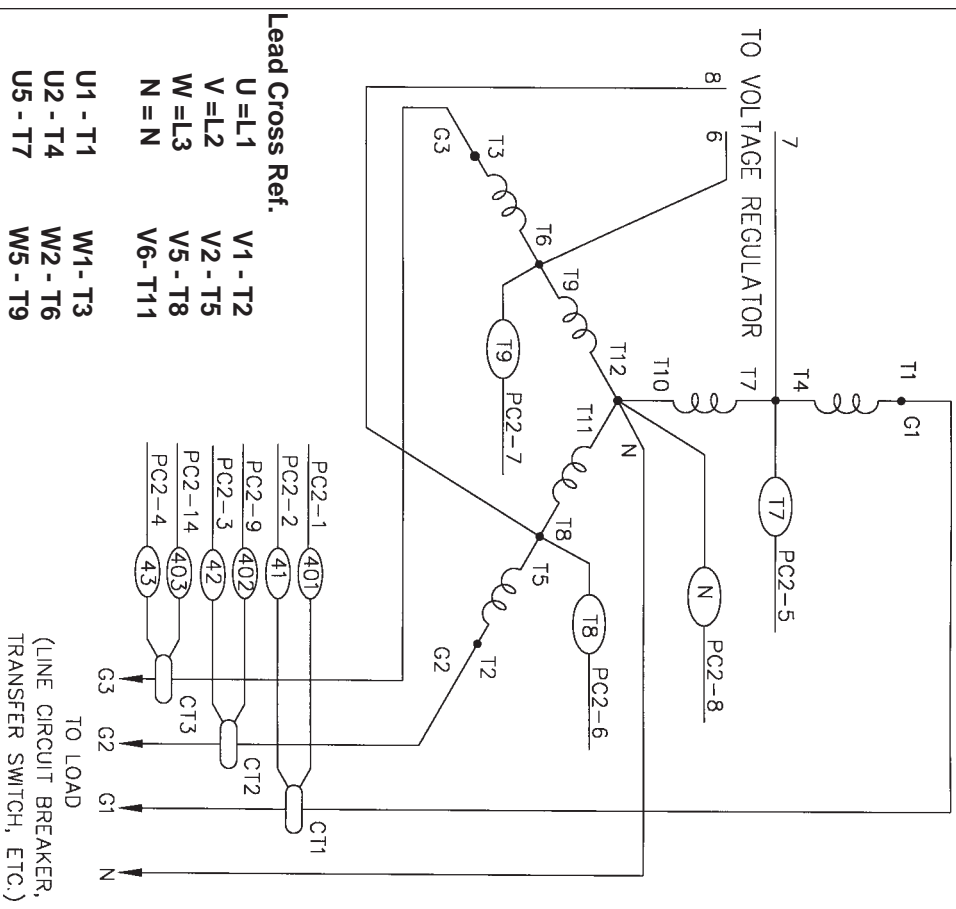

THREE PHASE AC WIRING - DELTA

SINGLE PHASE AC WIRING

THREE PHASE -DELTA 120/240 VOLTS

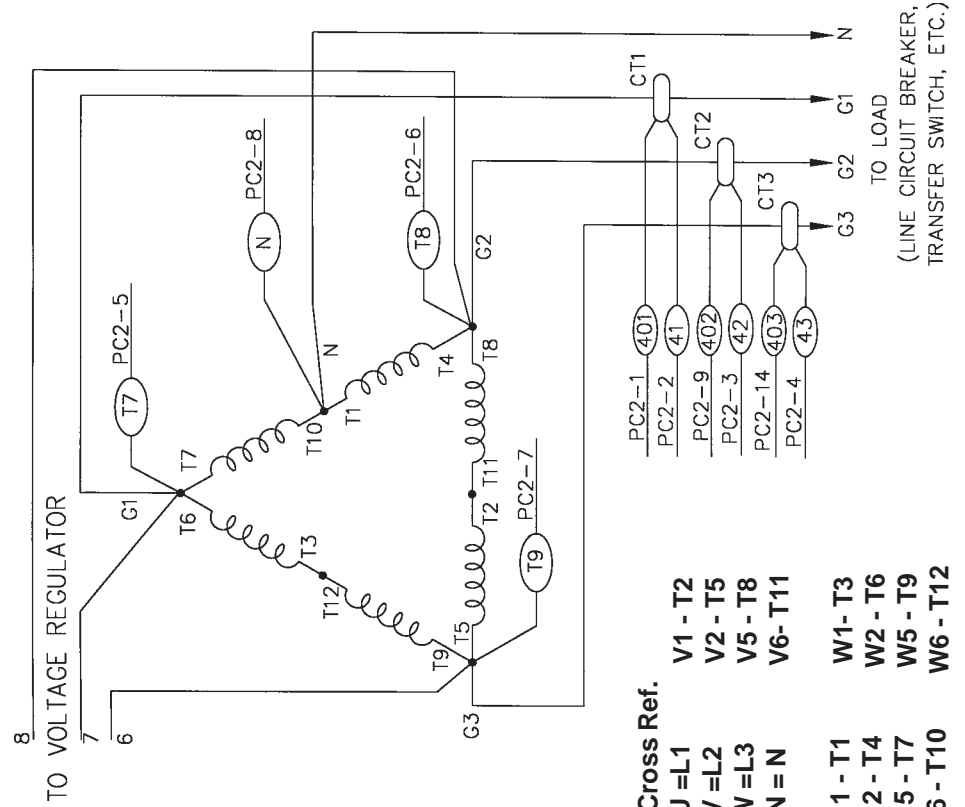

SINGLE PHASE 120/240 VOLTS

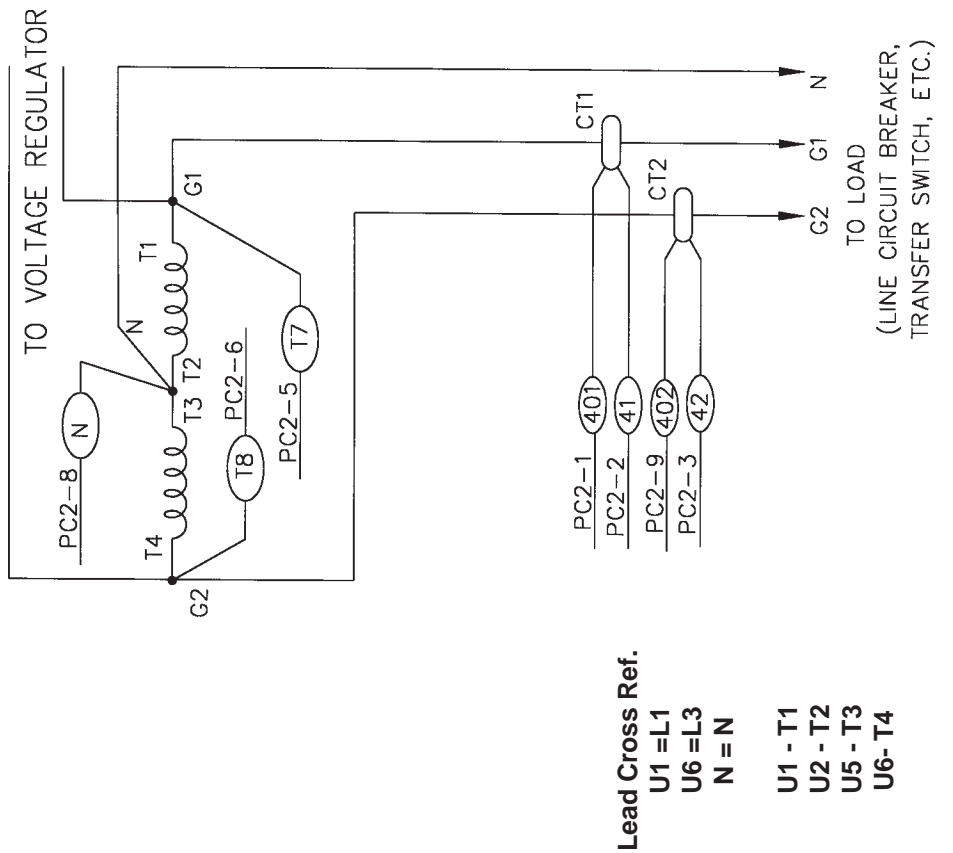

VOLTAGE REGULATOR WIRING THREE PHASE AND SINGLE PHASE

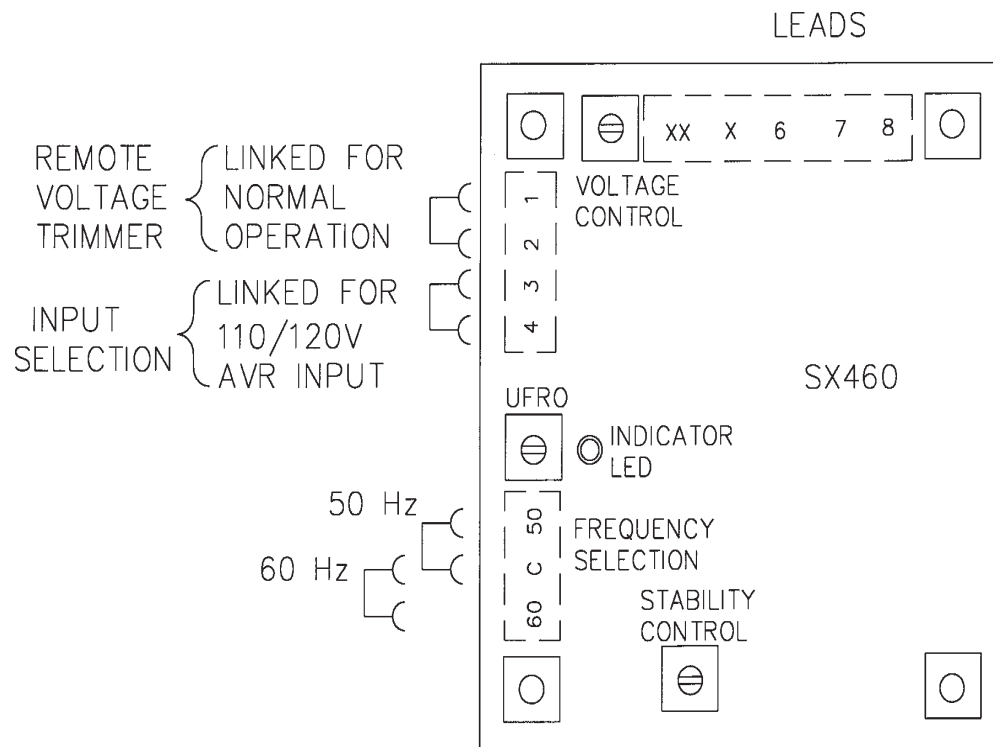

DC SCHEMATIC

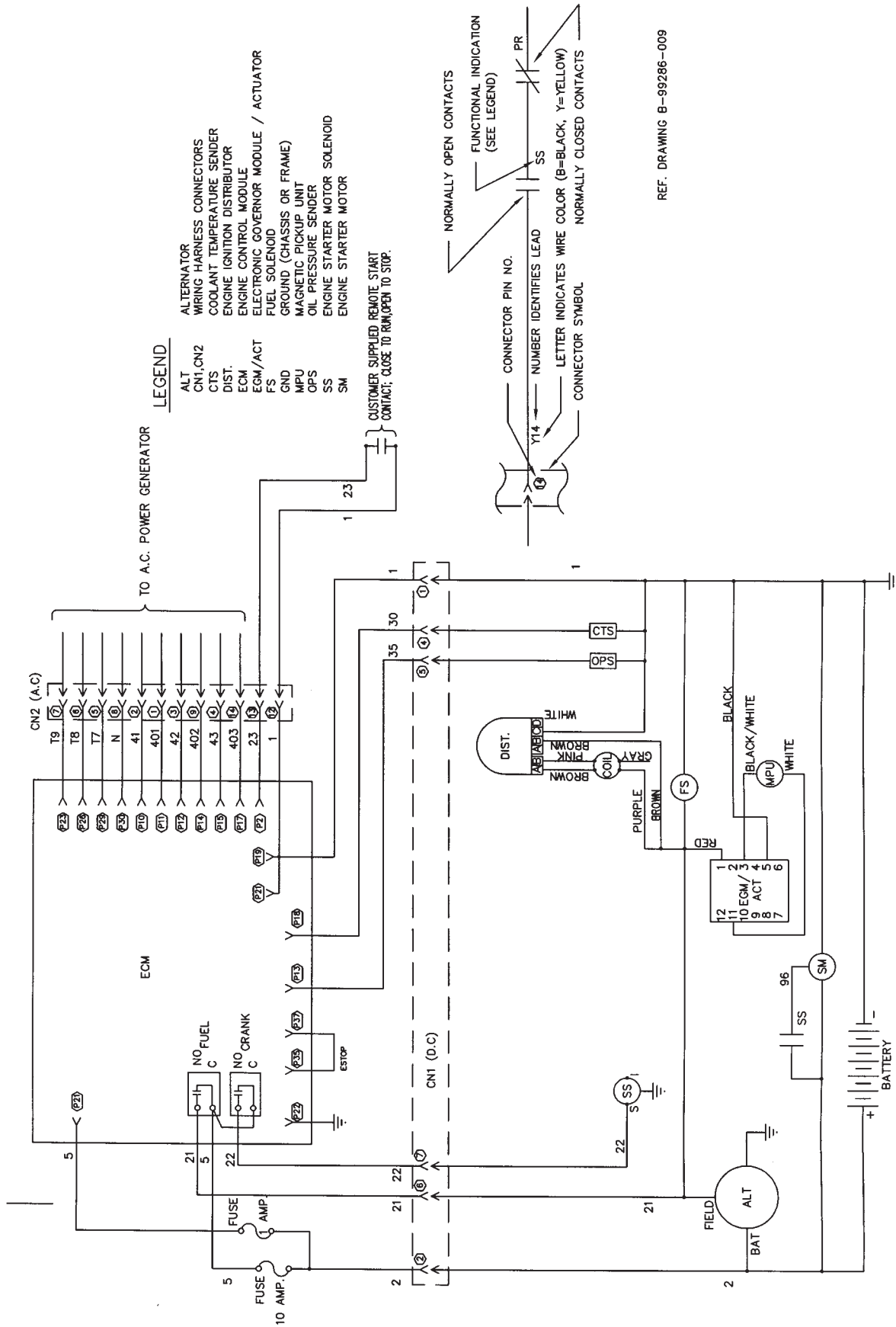

- NOTES:
1. DIMENSIONS ARE SUBJECT TO CHANGE. ALWAYS OBTAIN A CERTIFIED DRAWING FOR CONSTRUCTION PURPOSES.
 2. SIX MOUNTING HOLES 5/8" DIA. ARE PROVIDED IN BOTTOM OF BASE.

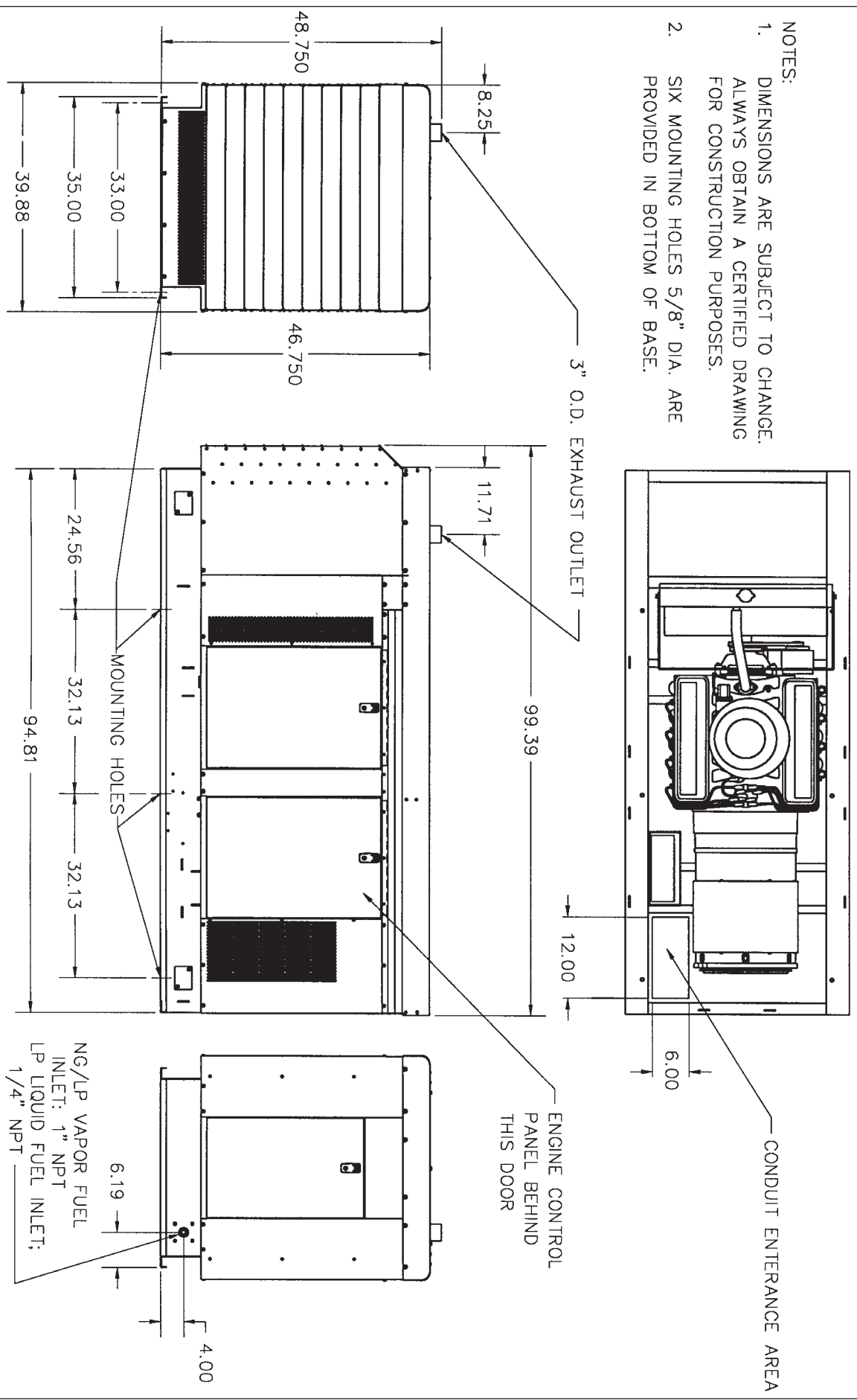

PSS50 & 75LS OUTLINE DRAWING AND WIRING ENTRANCE



12 MONTH LIMITED WARRANTY

WINCO, Incorporated warrants to the original purchaser for 12 months that goods manufactured or supplied by it will be free from defects in workmanship and material, provided such goods are installed, operated and maintained in accordance with WINCO written instructions.

WINCO's sole liability, and Purchaser's sole remedy for a failure under this warranty, shall be limited to the repair of the product. At WINCO's option, material found to be defective in material or workmanship under normal use and service will be repaired or replaced. For warranty service, return the product within 12 months from the date of purchase, transportation charges prepaid, to your nearest WINCO Authorized Service Center or to WINCO, Inc. at Le Center Minnesota.

THERE IS NO OTHER EXPRESS WARRANTY.

To the extent permitted by law, any and all warranties, including those of merchantability and fitness for a particular purpose, are limited to 12 months from date of purchase. In no event is WINCO liable for incidental or consequential damages.

Note: Some states do not allow limitation on the duration of implied warranty and some states do not allow the exclusion or limitation of incidental or consequential damages, so the above limitations may not apply in every instance. This warranty gives you specific legal rights which may vary from state to state.

WINCO reserves the right to change or improve its products without incurring any obligations to make such changes or improvement on products purchased previously.

EXCLUSIONS:

WINCO does not warrant engines, batteries, or other component parts that are warranted by their respective manufacturers.

WINCO does not warrant modifications or alterations which were not made by WINCO, Inc.

WINCO does not warrant products which have been subjected to misuse and/or negligence or have been involved in an accident.

WINCO INC[®]
*A Division of **DTE** Dyna Technology Inc*

225 SOUTH CORDOVA AVE
LE CENTER MN 56057
Phone - 507-357-6831
Fax - 507-357-4857
Website www.wincogen.com

60706-173-5234-00